

















EXPECT SOLUTIONS
**REPICO® PIPE COUPLINGS
AND REPAIR COUPLINGS**

Expect... **AVR**



TABLE OF CONTENTS

	Series 745/01 - Repico® G	5		Series 747/01 - Repico® RSD	27
	Series 745/11 - Repico® GP	9		Series 747/02 - Repico® RSDL	31
	Series 745/20 - Repico® S	10		Series 747/11 - Repico® RSDF	34
	Series 745/28 - Repico® SD	14		Series 747/12 - Repico® RSDFL	36
	Series 745/29 - Repico® SDL	18		Series 747/71 - Repico® RE	37
	Series 745/32 - Repico® SDF	21		Series 747/81 - Repico® RH	41
	Series 745/33 - Repico® SDFL	23		Series 747/82 - Repico® RHL	45
	Series 745/52 - Repico® SG	24			

EXPECT QUALITY

AVK REWAG (REpairing Water and Gas) is part of the internationally operating AVK Group and is the production location of AVK Nederland. AVK REWAG was originally started as REWAG Pipeline Products in 1991 where the production of stainless steel repair couplings took place.

In 2004 the company became a member of the AVK Group and changed its name into AVK REWAG. Throughout the years the product range has been expanded and innovated with stainless steel repair couplings with vulcanized spanner plate, stainless steel tapping saddles and QR transition couplings.

In 2011 the AVK REWAG production facility is completely updated. The last years the production has been expanded with welding robots and an own test facility. AVK REWAG has more than 40 year experience in manufacturing repair couplings and our products are sold in more than 40 countries.

A recent change was the integration of the Repico® product range moving from outsourced production to AVK REWAG production facility.

The production facility is expanded with a new building of 1000 m², according to the latest environmental requirements.

The production process is in accordance with ISO 9001, ISO 14001 and CSR Certificate Performance Ladder level 4.



NEW IN OUR REPICO® PROGRAM

Our new Repico® - Grip Plast coupling

provides a tensile / axial restraint connection for all plastic pipes, allows pipe section replacement and is suitable for high pressure. Available in DN 32-200.



AVK Repico® - Grip Plast coupling (GP)
Stainless steel 316, EPDM rubber



AVK Repico® - Grip Plast coupling (GP)
Stainless steel 316, NBR rubber

AVK's Repico® fire resistant cover (FRC) has been developed for fire protection applications up to max. +800°C for 30 minutes. The stainless steel body has been provided with a fire resistant sleeve. The Repico® FRC can be easily mounted over the complete product program of stainless steel Repico® pipe and repair couplings.

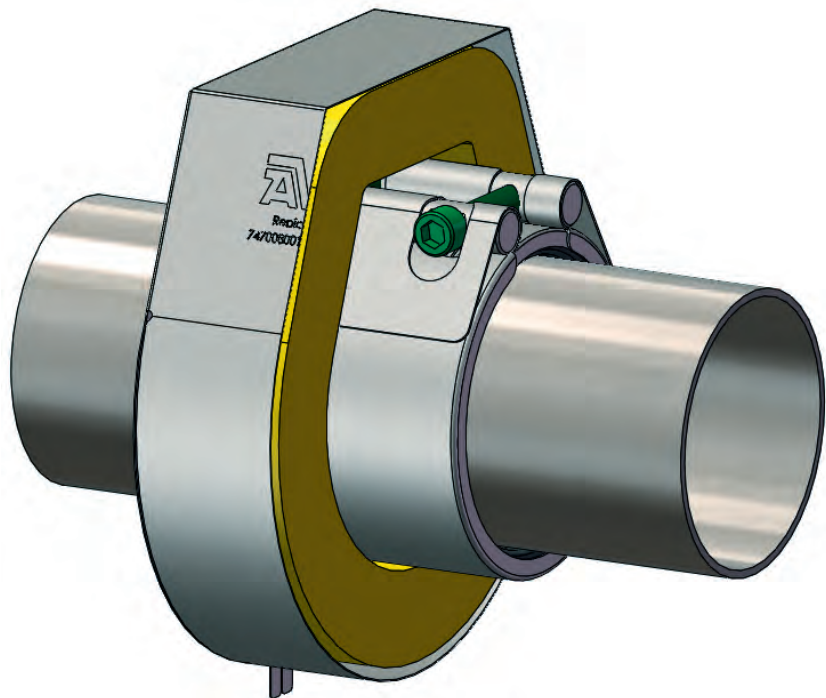

AVK Repico® - Fire resistant cover (FRC)
Stainless steel 316, EPDM rubber

745/01-111

Repico® G
 Grip type coupling
 Tensile/axial restraint
 For metal pipes
 Stainless steel
 EPDM drinking water
 approved



AVK ref. no.	DN mm	Tolerance mm	Pipe dia. mm	Working Pressure bar	Theoretical weight/kg	Gross Price EUR
745-01-0020-11101	15	19,5 - 20,5	20,0	42,7	0,2	75,71
745-01-0021-11101	15	21,2 - 22,2	21,3	42,7	0,2	76,88
745-01-0025-11101	20	24,5 - 25,5	25,0	42,7	0,3	91,13
745-01-0027-11101	20	26,7 - 27,7	26,7	42,7	0,3	92,50
745-01-0028-11101	25	27,5 - 29,0	28,2	42,7	0,3	95,05
745-01-0030-11101	25	29,5 - 30,5	30,0	42,7	0,3	96,46
745-01-0032-11101	25	31,5 - 32,5	32,0	42,7	0,4	97,89
745-01-0034-11101	25	33,0 - 34,6	33,4	42,7	0,4	99,37
745-01-0038-11101	32	37,5 - 38,5	38,0	42,7	0,4	103,08
745-01-0040-11101	32	39,5 - 41,5	40,0	42,7	0,4	104,64
745-01-0042-11101	32	41,9 - 43,0	42,2	42,7	0,4	106,17
745-01-0044-11101	32	44,0 - 45,0	44,5	42,7	0,4	107,77
745-01-0048-11101	40	47,8 - 49,0	48,3	42,7	0,4	109,39
745-01-0050-11101	50	49,5 - 51,5	50,8	42,7	0,4	117,30
745-01-0054-11101	50	53,4 - 54,6	54,0	42,7	0,7	119,03
745-01-0057-11101	50	56,4 - 57,6	57,0	42,7	0,7	120,83
745-01-0060-11101	50	59,0 - 61,5	60,3	42,7	0,7	122,63
745-01-0063-11101	50	62,4 - 63,6	63,0	42,7	0,7	124,50
745-01-0066-11101	65	65,2 - 67,3	66,7	37,3	0,7	139,47
745-01-0069-11101	65	68,0 - 70,1	69,0	37,3	0,7	141,53
745-01-0073-11101	65	71,5 - 74,1	73,0	37,3	0,8	143,65
745-01-0076-11101	65	75,0 - 77,2	76,1	37,3	0,8	145,84
745-01-0079-11101	80	78,8 - 80,8	79,9	37,3	1,4	160,74
745-01-0084-11101	80	83,0 - 84,9	84,0	37,3	1,4	163,19
745-01-0089-11101	80	87,8 - 91,0	88,9	37,3	1,4	165,63
745-01-0101-11101	100	100,4 - 102,0	101,6	37,3	1,5	168,52
745-01-0104-11101	100	103,0 - 104,0	104,0	37,3	1,6	176,30
745-01-0106-11101	100	105,0 - 107,0	106,3	37,3	1,6	178,93
745-01-0108-11101	100	106,5 - 108,0	108,0	37,3	1,6	181,63
745-01-0114-11101	100	113,2 - 115,0	114,3	37,3	1,7	184,32
745-01-0127-11101	125	125,6 - 128,0	127,0	37,3	2,1	282,15
745-01-0129-11101	125	127,5 - 130,0	129,0	37,3	2,1	286,40
745-01-0133-11101	125	131,6 - 134,0	131,7	37,3	2,1	290,71
745-01-0139-11101	125	137,7 - 140,0	139,7	37,3	2,2	295,01
745-01-0141-11101	125	139,7 - 142,0	141,3	37,3	2,2	299,45
745-01-0154-11101	150	151,5 - 155,0	154,0	32	2,3	321,88
745-01-0159-11101	150	156,5 - 160,0	157,7	32	2,3	326,70
745-01-0165-11101	150	163,3 - 166,0	165,2	32	2,4	331,64
745-01-0168-11101	150	166,6 - 170,0	168,3	32	2,4	336,60
745-01-0180-11101	175	178,0 - 182,0	180,0	26,7	2,5	341,67
745-01-0200-11101	200	198,2 - 201,0	200,0	21,3	4,6	509,68
745-01-0204-11101	200	202,7 - 206,0	204,0	21,3	4,7	517,33
745-01-0216-11101	200	214,5 - 218,0	216,3	21,3	4,8	525,11
745-01-0219-11101	200	217,0 - 221,0	219,1	21,3	4,9	532,94
745-01-0254-11101	250	251,4 - 256,0	254,0	21,3	5,3	647,09
745-01-0267-11101	250	264,8 - 270,0	267,4	21,3	5,5	656,81
745-01-0273-11101	250	270,4 - 275,0	273,0	21,3	5,6	666,63
745-01-0304-11101	300	301,5 - 306,0	304,0	18,7	6,0	701,35
745-01-0318-11101	300	316,0 - 322,0	318,5	18,7	6,2	711,87
745-01-0323-11101	300	321,0 - 327,0	323,9	18,7	6,3	722,56
745-01-0355-11101	350	352,0 - 360,0	355,6	18,7	6,7	829,25
745-01-0406-11101	400	402,0 - 410,0	406,4	16	7,4	899,04

745/01-112

Repico® G
 Grip type coupling
 Tensile / axial restraint
 For metal pipes
 Stainless steel
 NBR rubber



AVK ref. no.	DN mm	Tolerance mm	Pipe dia. mm	Working Pressure bar	Theoretical weight/kg	Gross Price EUR
745-01-0020-11201	15	19,5 - 20,5	20,0	42,7	0,2	75.71
745-01-0021-11201	15	21,2 - 22,2	21,3	42,7	0,2	76.88
745-01-0025-11201	20	24,5 - 25,5	25,0	42,7	0,3	91.13
745-01-0027-11201	20	26,7 - 27,7	26,7	42,7	0,3	92.50
745-01-0028-11201	25	27,5 - 29,0	28,2	42,7	0,3	95.05
745-01-0030-11201	25	29,5 - 30,5	30,0	42,7	0,3	96.46
745-01-0032-11201	25	31,5 - 32,5	32,0	42,7	0,4	97.89
745-01-0034-11201	25	33,0 - 34,6	33,4	42,7	0,4	99.37
745-01-0038-11201	32	37,5 - 38,5	38,0	42,7	0,4	103.08
745-01-0040-11201	32	39,5 - 41,5	40,0	42,7	0,4	104.64
745-01-0042-11201	32	41,9 - 43,0	42,2	42,7	0,4	106.17
745-01-0044-11201	32	44,0 - 45,0	44,5	42,7	0,4	107.77
745-01-0048-11201	40	47,8 - 49,0	48,3	42,7	0,4	109.39
745-01-0050-11201	50	49,5 - 51,5	50,8	42,7	0,4	117.30
745-01-0054-11201	50	53,4 - 54,6	54,0	42,7	0,7	119.03
745-01-0057-11201	50	56,4 - 57,6	57,0	42,7	0,7	120.83
745-01-0060-11201	50	59,0 - 61,5	60,3	42,7	0,7	122.63
745-01-0063-11201	50	62,4 - 63,6	63,0	42,7	0,7	124.50
745-01-0066-11201	65	65,2 - 67,3	66,7	37,3	0,7	139.47
745-01-0069-11201	65	68,0 - 70,1	69,0	37,3	0,7	141.53
745-01-0073-11201	65	71,5 - 74,1	73,0	37,3	0,8	143.65
745-01-0076-11201	65	75,0 - 77,2	76,1	37,3	0,8	145.84
745-01-0079-11201	80	78,8 - 80,8	79,9	37,3	1,4	160.74
745-01-0084-11201	80	83,0 - 84,9	84,0	37,3	1,4	163.19
745-01-0089-11201	80	87,8 - 91,0	88,9	37,3	1,4	165.63
745-01-0101-11201	100	100,4 - 102,0	101,6	37,3	1,5	168.52
745-01-0104-11201	100	103,0 - 104,0	104,0	37,3	1,6	176.30
745-01-0106-11201	100	105,0 - 107,0	106,3	37,3	1,6	178.93
745-01-0108-11201	100	106,5 - 108,0	108,0	37,3	1,6	181.63
745-01-0114-11201	100	113,2 - 115,0	114,3	37,3	1,7	184.32
745-01-0127-11201	125	125,6 - 128,0	127,0	37,3	2,1	282.15
745-01-0129-11201	125	127,5 - 130,0	129,0	37,3	2,1	286.40
745-01-0133-11201	125	131,6 - 134,0	131,7	37,3	2,1	290.71
745-01-0139-11201	125	137,7 - 140,0	139,7	37,3	2,2	295.01
745-01-0141-11201	125	139,7 - 142,0	141,3	37,3	2,2	299.45
745-01-0154-11201	150	151,5 - 155,0	154,0	32	2,3	321.88
745-01-0159-11201	150	156,5 - 160,0	157,7	32	2,3	326.70
745-01-0165-11201	150	163,3 - 166,0	165,2	32	2,4	331.64
745-01-0168-11201	150	166,6 - 170,0	168,3	32	2,4	336.60
745-01-0180-11201	175	178,0 - 182,0	180,0	26,7	2,5	341.67
745-01-0200-11201	200	198,2 - 201,0	200,0	21,3	4,6	509.68
745-01-0204-11201	200	202,7 - 206,0	204,0	21,3	4,7	517.33
745-01-0216-11201	200	214,5 - 218,0	216,3	21,3	4,8	525.11
745-01-0219-11201	200	217,0 - 221,0	219,1	21,3	4,9	532.94
745-01-0254-11201	250	251,4 - 256,0	254,0	21,3	5,3	647.09
745-01-0267-11201	250	264,8 - 270,0	267,4	21,3	5,5	656.81
745-01-0273-11201	250	270,4 - 275,0	273,0	21,3	5,6	666.63
745-01-0304-11201	300	301,5 - 306,0	304,0	18,7	6,0	701.35
745-01-0318-11201	300	316,0 - 322,0	318,5	18,7	6,2	711.87
745-01-0323-11201	300	321,0 - 327,0	323,9	18,7	6,3	722.56
745-01-0355-11201	350	352,0 - 360,0	355,6	18,7	6,7	829.25
745-01-0406-11201	400	402,0 - 410,0	406,4	16	7,4	899.04

745/01-113

Repico® G
 Grip type coupling
 Tensile / axial restraint
 For metal pipes
 Stainless steel
 Silicone rubber



AVK ref. no.	DN mm	Tolerance mm	Pipe dia. mm	Working Pressure bar	Theoretical weight/kg	Gross Price EUR
745-01-0020-11301	15	19,5 - 20,5	20,0	42	0.2	103.08
745-01-0021-11301	15	21,2 - 22,2	21,3	42	0.2	104.64
745-01-0025-11301	20	24,5 - 25,5	25,0	42	0.3	106.95
745-01-0027-11301	20	26,7 - 27,7	26,7	42	0.3	107.52
745-01-0028-11301	25	27,5 - 29,0	28,2	42	0.3	108.05
745-01-0030-11301	25	29,5 - 30,5	30,0	42	0.3	109.64
745-01-0032-11301	25	31,5 - 32,5	32,0	42	0.4	111.34
745-01-0034-11301	25	33,0 - 34,6	33,4	42	0.4	113.00
745-01-0038-11301	32	37,5 - 38,5	38,0	42	0.4	118.91
745-01-0040-11301	32	39,5 - 41,5	40,0	42	0.4	120.63
745-01-0042-11301	32	41,9 - 43,0	42,2	42	0.4	122.51
745-01-0044-11301	32	44,0 - 45,0	44,5	42	0.4	124.31
745-01-0048-11301	40	47,8 - 49,0	48,3	42	0.4	126.18
745-01-0050-11301	50	49,5 - 51,5	50,8	42	0.4	142.69
745-01-0054-11301	50	53,4 - 54,6	54,0	42	0.7	144.81
745-01-0057-11301	50	56,4 - 57,6	57,0	42	0.7	147.00
745-01-0060-11301	50	59,0 - 61,5	60,3	42	0.7	149.18
745-01-0063-11301	50	62,4 - 63,6	63,0	42	0.7	151.42
745-01-0066-11301	65	65,2 - 67,3	66,7	37	0.7	181.31
745-01-0069-11301	65	68,0 - 70,1	69,0	37	0.7	184.08
745-01-0073-11301	65	71,5 - 74,1	73,0	37	0.8	186.84
745-01-0076-11301	65	75,0 - 77,2	76,1	37	0.8	189.59
745-01-0079-11301	80	78,8 - 80,8	79,9	37	1.4	191.53
745-01-0084-11301	80	83,0 - 84,9	84,0	37	1.4	194.37
745-01-0089-11301	80	87,8 - 91,0	88,9	37	1.4	197.31
745-01-0101-11301	100	100,4 - 102,0	101,6	37	1.5	208.75
745-01-0104-11301	100	103,0 - 104,0	104,0	37	1.6	217.82
745-01-0106-11301	100	105,0 - 107,0	106,3	37	1.6	221.10
745-01-0108-11301	100	106,5 - 108,0	108,0	37	1.6	224.38
745-01-0114-11301	100	113,2 - 115,0	114,3	37	1.7	348.42
745-01-0127-11301	125	125,6 - 128,0	127,0	37	2.1	351.89
745-01-0129-11301	125	127,5 - 130,0	129,0	37	2.1	357.16
745-01-0133-11301	125	131,6 - 134,0	131,7	37	2.1	362.49
745-01-0139-11301	125	137,7 - 140,0	139,7	37	2.2	372.20
745-01-0141-11301	125	139,7 - 142,0	141,3	37	2.2	377.79
745-01-0154-11301	150	151,5 - 155,0	154,0	32	2.3	398.99
745-01-0159-11301	150	156,5 - 160,0	157,7	32	2.3	404.99
745-01-0165-11301	150	163,3 - 166,0	165,2	32	2.4	411.10
745-01-0168-11301	150	166,6 - 170,0	168,3	32	2.4	417.27
745-01-0180-11301	175	178,0 - 182,0	180,0	26	2.5	423.50
745-01-0200-11301	200	198,2 - 201,0	200,0	21	4.6	687.39
745-01-0204-11301	200	202,7 - 206,0	204,0	21	4.7	697.74
745-01-0216-11301	200	214,5 - 218,0	216,3	21	4.8	708.23
745-01-0219-11301	200	217,0 - 221,0	219,1	21	4.9	794.34
745-01-0254-11301	250	251,4 - 256,0	254,0	21	5.3	875.78
745-01-0267-11301	250	264,8 - 270,0	267,4	21	5.5	888.89
745-01-0273-11301	250	270,4 - 275,0	273,0	21	5.6	902.26
745-01-0304-11301	300	301,5 - 306,0	304,0	18	6.0	945.51
745-01-0318-11301	300	316,0 - 322,0	318,5	18	6.2	959.66
745-01-0323-11301	300	321,0 - 327,0	323,9	18	6.3	974.05
745-01-0355-11301	350	352,0 - 360,0	355,6	18	6.7	1,108.24
745-01-0406-11301	400	402,0 - 410,0	406,4	16	7.4	1,224.53

745/01-114

Repico® G
 Grip type coupling
 Tensile / axial restraint
 For metal pipes
 Stainless steel



AVK ref. no.	DN mm	Tolerance mm	Pipe dia. mm	Working Pressure bar	Theoretical weight/kg	Gross Price EUR
745-01-0020-11401	15	19,5 - 20,5	20,0	42	0.2	158.56
745-01-0021-11401	15	21,2 - 22,2	21,3	42	0.2	160.94
745-01-0025-11401	20	24,5 - 25,5	25,0	42	0.3	174.36
745-01-0027-11401	20	26,7 - 27,7	26,7	42	0.3	176.94
745-01-0028-11401	25	27,5 - 29,0	28,2	42	0.3	194.23
745-01-0030-11401	25	29,5 - 30,5	30,0	42	0.3	197.12
745-01-0032-11401	25	31,5 - 32,5	32,0	42	0.4	200.09
745-01-0034-11401	25	33,0 - 34,6	33,4	42	0.4	203.10
745-01-0038-11401	32	37,5 - 38,5	38,0	42	0.4	221.94
745-01-0040-11401	32	39,5 - 41,5	40,0	42	0.4	225.27
745-01-0042-11401	32	41,9 - 43,0	42,2	42	0.4	228.69
745-01-0044-11401	32	44,0 - 45,0	44,5	42	0.4	232.09
745-01-0048-11401	40	47,8 - 49,0	48,3	42	0.4	235.57
745-01-0050-11401	50	49,5 - 51,5	50,8	42	0.4	239.09
745-01-0054-11401	50	53,4 - 54,6	54,0	42	0.7	304.34
745-01-0057-11401	50	56,4 - 57,6	57,0	42	0.7	308.90
745-01-0060-11401	50	59,0 - 61,5	60,3	42	0.7	313.53
745-01-0063-11401	50	62,4 - 63,6	63,0	42	0.7	318.21
745-01-0066-11401	65	65,2 - 67,3	66,7	37	0.7	411.54
745-01-0069-11401	65	68,0 - 70,1	69,0	37	0.7	417.71
745-01-0073-11401	65	71,5 - 74,1	73,0	37	0.8	424.00
745-01-0076-11401	65	75,0 - 77,2	76,1	37	0.8	430.38
745-01-0079-11401	80	78,8 - 80,8	79,9	37	1.4	549.78
745-01-0084-11401	80	83,0 - 84,9	84,0	37	1.4	558.01
745-01-0089-11401	80	87,8 - 91,0	88,9	37	1.4	566.36
745-01-0101-11401	100	100,4 - 102,0	101,6	37	1.5	625.69
745-01-0104-11401	100	103,0 - 104,0	104,0	37	1.6	697.54
745-01-0106-11401	100	105,0 - 107,0	106,3	37	1.6	708.03
745-01-0108-11401	100	106,5 - 108,0	108,0	37	1.6	718.64
745-01-0114-11401	100	113,2 - 115,0	114,3	37	1.7	824.36
745-01-0127-11401	125	125,6 - 128,0	127,0	37	2.1	836.76
745-01-0129-11401	125	127,5 - 130,0	129,0	37	2.1	849.29
745-01-0133-11401	125	131,6 - 134,0	131,7	37	2.1	1,049.44
745-01-0139-11401	125	137,7 - 140,0	139,7	37	2.2	1,065.19
745-01-0141-11401	125	139,7 - 142,0	141,3	37	2.2	1,081.14
745-01-0154-11401	150	151,5 - 155,0	154,0	32	2.3	1,317.91
745-01-0159-11401	150	156,5 - 160,0	157,7	32	2.3	1,337.65
745-01-0165-11401	150	163,3 - 166,0	165,2	32	2.4	1,357.68
745-01-0168-11401	150	166,6 - 170,0	168,3	32	2.4	1,378.07
745-01-0180-11401	175	178,0 - 182,0	180,0	26	2.5	1,398.77
745-01-0200-11401	200	198,2 - 201,0	200,0	21	4.6	2,058.98
745-01-0204-11401	200	202,7 - 206,0	204,0	21	4.7	2,089.83
745-01-0216-11401	200	214,5 - 218,0	216,3	21	4.8	2,121.20
745-01-0219-11401	200	217,0 - 221,0	219,1	21	4.9	2,379.26
745-01-0254-11401	250	251,4 - 256,0	254,0	21	5.3	2,414.91
745-01-0267-11401	250	264,8 - 270,0	267,4	21	5.5	2,914.00
745-01-0273-11401	250	270,4 - 275,0	273,0	21	5.6	2,957.71
745-01-0304-11401	300	301,5 - 306,0	304,0	18	6.0	3,002.06
745-01-0318-11401	300	316,0 - 322,0	318,5	18	6.2	3,316.99
745-01-0323-11401	300	321,0 - 327,0	323,9	18	6.3	3,366.74
745-01-0355-11401	350	352,0 - 360,0	355,6	18	6.7	3,971.88
745-01-0406-11401	400	402,0 - 410,0	406,4	16	7.4	4,456.24

745/11-111

Repico® GP
Grip Plast type coupling
Tensile / axial restraint
For plastic pipes
Stainless steel
EPDM drinking water
approved



AVK ref. no.	DN mm	Tolerance mm	Pipe dia. mm	Working Pressure bar	Theoretical weight/kg	Gross Price EUR
745-11-0050-11111	40	49,5 - 51,5	50,0	16	0.4	167.28
745-11-0063-11111	50	62,4 - 63,6	63,0	16	0.7	167.28
745-11-0075-11111	65	74,0 - 76,2	75,0	16	0.8	214.12
745-11-0090-11111	80	87,8 - 91,0	90,0	16	1.4	227.50
745-11-0110-11111	100	108,5 - 110,5	110,0	16	1.6	250.92
745-11-0160-11111	150	157,5 - 161,0	160,0	16	2.3	451.66
745-11-0200-11111	200	198,2 - 201,5	200,0	16	4.6	676.93

745/11-112

Repico® GP
Grip Plast type coupling
Tensile / axial restraint
For plastic pipes
Stainless steel
NBR rubber



AVK ref. no.	DN mm	Tolerance mm	Pipe dia. mm	Working Pressure bar	Theoretical weight/kg	Gross Price EUR
745-11-0050-11211	40	49,5 - 51,5	50,0	16	0.4	167.28
745-11-0063-11211	50	62,4 - 63,6	63,0	16	0.7	167.28
745-11-0075-11211	65	74,0 - 76,2	75,0	16	0.8	214.12
745-11-0090-11211	80	87,8 - 91,0	90,0	16	1.4	227.50
745-11-0110-11211	100	108,5 - 110,5	110,0	16	1.6	250.92
745-11-0160-11211	150	157,5 - 161,0	160,0	16	2.3	451.66
745-11-0200-11211	200	198,2 - 201,5	200,0	16	4.6	676.93

745/20-111

Repico® S
Slip type coupling
Non-tensile/flexible
For all pipe types
Stainless steel
EPDM drinking water
approved



AVK ref. no.	DN mm	Tolerance mm	Pipe dia. mm	Working Pressure bar	Theoretical weight/kg	Gross Price EUR
745-20-0020-111	15	19,5 - 20,5	20,0	42,7	0,2	70,57
745-20-0021-111	15	21,0 - 22,0	21,3	42,7	0,2	71,66
745-20-0025-111	20	24,0 - 26,0	25,0	42,7	0,3	87,16
745-20-0027-111	20	26,0 - 28,0	26,7	42,7	0,3	88,50
745-20-0028-111	25	26,4 - 29,0	28,2	42,7	0,3	91,34
745-20-0030-111	25	29,0 - 31,0	30,0	42,7	0,3	92,68
745-20-0032-111	25	31,0 - 33,0	32,0	42,7	0,3	94,11
745-20-0034-111	25	33,0 - 35,0	33,4	42,7	0,3	95,51
745-20-0038-111	32	37,0 - 39,0	38,0	42,7	0,4	95,51
745-20-0040-111	32	39,5 - 41,3	40,0	42,7	0,4	96,46
745-20-0042-111	32	42,0 - 44,0	42,2	42,7	0,4	97,44
745-20-0044-111	32	44,0 - 46,0	44,5	42,7	0,4	98,41
745-20-0048-111	40	47,5 - 49,5	48,3	42,7	0,4	99,62
745-20-0050-111	50	49,2 - 51,5	50,8	42,7	0,4	101,49
745-20-0054-111	50	53,0 - 55,0	54,0	42,7	0,6	102,97
745-20-0057-111	50	56,0 - 58,0	57,0	42,7	0,6	104,51
745-20-0060-111	50	59,0 - 61,5	60,3	42,7	0,6	106,11
745-20-0063-111	50	62,0 - 64,0	63,0	42,7	0,6	107,72
745-20-0066-111	65	65,4 - 68,3	66,7	37,3	0,6	110,94
745-20-0069-111	65	68,5 - 71,0	69,0	37,3	0,7	111,52
745-20-0073-111	65	72,5 - 75,5	73,0	37,3	0,7	112,03
745-20-0076-111	65	75,0 - 78,0	76,1	37,3	0,7	112,61
745-20-0079-111	80	78,8 - 82,0	79,9	37,3	1,3	113,19
745-20-0084-111	80	82,5 - 85,5	84,0	37,3	1,3	114,85
745-20-0089-111	80	88,0 - 91,0	88,9	37,3	1,3	116,60
745-20-0101-111	100	100,0 - 103,0	101,6	37,3	1,4	118,72
745-20-0104-111	100	102,0 - 105,0	104,0	37,3	1,4	120,52
745-20-0106-111	100	105,0 - 107,0	106,3	37,3	1,4	122,30
745-20-0108-111	100	106,0 - 109,0	108,0	37,3	1,4	123,54
745-20-0110-111	100	108,5 - 111,5	110,0	37,2	1,4	123,85
745-20-0114-111	100	113,0 - 116,0	114,3	37,3	1,4	123,98
745-20-0127-111	125	125,0 - 129,0	127,0	37,3	1,8	163,63
745-20-0129-111	125	127,5 - 130,0	129,0	37,3	1,8	166,07
745-20-0133-111	125	131,0 - 135,0	131,7	37,3	1,8	168,52
745-20-0139-111	125	138,0 - 142,0	139,7	37,3	1,9	171,09
745-20-0141-111	125	139,5 - 143,0	141,3	37,3	1,9	173,67
745-20-0154-111	150	151,5 - 155,0	154,0	32	2,0	176,56
745-20-0159-111	150	156,0 - 160,0	157,7	32	2,0	179,19
745-20-0165-111	150	164,0 - 167,0	165,2	32	2,1	181,89
745-20-0168-111	150	166,0 - 170,0	168,3	32	2,1	184,60
745-20-0180-111	175	178,0 - 182,0	180,0	26,7	2,2	190,82
745-20-0200-111	200	198,0 - 203,0	200,0	21,3	4,2	313,38
745-20-0204-111	200	202,0 - 206,0	204,0	21,3	4,2	318,10
745-20-0216-111	200	214,0 - 218,0	216,3	21,3	4,4	322,84
745-20-0219-111	200	216,5 - 221,0	219,1	21,3	4,4	327,67
745-20-0250-111	250	247,0 - 253,0	250,0	21,3	4,8	339,63
745-20-0254-111	225	251,0 - 257,0	254,0	21,3	4,8	341,67
745-20-0267-111	250	262,0 - 269,0	267,4	21,3	5,0	346,82
745-20-0273-111	250	270,0 - 276,0	273,0	21,3	5,0	352,03
745-20-0304-111	300	301,5 - 308,0	304,0	18,7	5,4	367,57
745-20-0315-111	300	312,0 - 318,5	315,0	18,7	5,5	371,33
745-20-0318-111	300	316,0 - 322,0	318,5	18,7	5,5	373,10
745-20-0323-111	300	322,0 - 328,0	323,9	18,7	5,6	378,69
745-20-0355-111	350	352,0 - 360,0	355,6	18,7	6,0	433,58
745-20-0400-111	400	396,0 - 404,0	400,0	16	5,0	464,35
745-20-0406-111	400	402,0 - 410,0	406,4	16	6,5	466,56
745-20-0457-111	450	453,0 - 460,0	457,2	16	7,1	518,42
745-20-0500-111	500	496,0 - 504,0	500,0	13	6,0	560,72
745-20-0508-111	500	504,0 - 512,0	508,0	13	7,7	563,22
745-20-0558-111	550	555,0 - 563,0	558,8	12	8,3	607,96
745-20-0609-111	600	605,0 - 614,0	609,6	11	8,8	647,98
745-20-0616-111	600	612,0 - 621,0	616,0	11	8,0	660,94

745/20-112

Repico® S
Slip type coupling
Non-tensile / flexible
For all pipe types
Stainless steel
NBR rubber



AVK ref. no.	DN mm	Tolerance mm	Pipe dia. mm	Working Pressure bar	Theoretical weight/kg	Gross Price EUR
745-20-0020-112	15	19,5 - 20,5	20,0	42,7	0,2	70,57
745-20-0021-112	15	21,0 - 22,0	21,3	42,7	0,2	71,66
745-20-0025-112	20	24,0 - 26,0	25,0	42,7	0,3	87,16
745-20-0027-112	20	26,0 - 28,0	26,7	42,7	0,3	88,50
745-20-0028-112	25	26,4 - 29,0	28,2	42,7	0,3	91,34
745-20-0030-112	25	29,0 - 31,0	30,0	42,7	0,3	92,68
745-20-0032-112	25	31,0 - 33,0	32,0	42,7	0,3	94,11
745-20-0034-112	25	33,0 - 35,0	33,4	42,7	0,3	95,51
745-20-0038-112	32	37,0 - 39,0	38,0	42,7	0,4	95,51
745-20-0040-112	32	39,5 - 41,3	40,0	42,7	0,4	96,46
745-20-0042-112	32	42,0 - 44,0	42,2	42,7	0,4	97,44
745-20-0044-112	32	44,0 - 46,0	44,5	42,7	0,4	98,41
745-20-0048-112	40	47,5 - 49,5	48,3	42,7	0,4	99,62
745-20-0050-112	50	49,2 - 51,5	50,8	42,7	0,4	101,49
745-20-0054-112	50	53,0 - 55,0	54,0	42,7	0,6	102,97
745-20-0057-112	50	56,0 - 58,0	57,0	42,7	0,6	104,51
745-20-0060-112	50	59,0 - 61,5	60,3	42,7	0,6	106,11
745-20-0063-112	50	62,0 - 64,0	63,0	42,7	0,6	107,72
745-20-0066-112	65	65,4 - 68,3	66,7	37,3	0,6	110,94
745-20-0069-112	65	68,5 - 71,0	69,0	37,3	0,7	111,52
745-20-0073-112	65	72,5 - 75,5	73,0	37,3	0,7	112,03
745-20-0076-112	65	75,0 - 78,0	76,1	37,3	0,7	112,61
745-20-0079-112	80	78,8 - 82,0	79,9	37,3	1,3	113,19
745-20-0084-112	80	82,5 - 85,5	84,0	37,3	1,3	114,85
745-20-0089-112	80	88,0 - 91,0	88,9	37,3	1,3	116,60
745-20-0101-112	100	100,0 - 103,0	101,6	37,3	1,4	118,72
745-20-0104-112	100	102,0 - 105,0	104,0	37,3	1,4	120,52
745-20-0106-112	100	105,0 - 107,0	106,3	37,3	1,4	122,30
745-20-0108-112	100	106,0 - 109,0	108,0	37,3	1,4	123,54
745-20-0114-112	100	113,0 - 116,0	114,3	37,3	1,4	123,98
745-20-0127-112	125	125,0 - 129,0	127,0	37,3	1,8	163,63
745-20-0129-112	125	127,5 - 130,0	129,0	37,3	1,8	166,07
745-20-0133-112	125	131,0 - 135,0	131,7	37,3	1,8	168,52
745-20-0139-112	125	138,0 - 142,0	139,7	37,3	1,9	171,09
745-20-0141-112	125	139,5 - 143,0	141,3	37,3	1,9	173,67
745-20-0154-112	150	151,5 - 155,0	154,0	32	2,0	176,56
745-20-0159-112	150	156,0 - 160,0	157,7	32	2,0	179,19
745-20-0165-112	150	164,0 - 167,0	165,2	32	2,1	181,89
745-20-0168-112	150	166,0 - 170,0	168,3	32	2,1	184,60
745-20-0180-112	175	178,0 - 182,0	180,0	26,7	2,2	190,82
745-20-0200-112	200	198,0 - 203,0	200,0	21,3	4,2	313,38
745-20-0204-112	200	202,0 - 206,0	204,0	21,3	4,2	318,10
745-20-0216-112	200	214,0 - 218,0	216,3	21,3	4,4	322,84
745-20-0219-112	200	216,5 - 221,0	219,1	21,3	4,4	327,67
745-20-0254-112	225	251,0 - 257,0	254,0	21,3	4,8	341,67
745-20-0267-112	250	262,0 - 269,0	267,4	21,3	5,0	346,82
745-20-0273-112	250	270,0 - 276,0	273,0	21,3	5,0	352,03
745-20-0304-112	300	301,5 - 308,0	304,0	18,7	5,4	367,57
745-20-0318-112	300	316,0 - 322,0	318,5	18,7	5,5	373,10
745-20-0323-112	300	322,0 - 328,0	323,9	18,7	5,6	378,69
745-20-0355-112	350	352,0 - 360,0	355,6	18,7	6,0	433,58
745-20-0400-112	400	396,0 - 404,0	400,0	16	6,5	464,35
745-20-0406-112	400	402,0 - 410,0	406,4	16	6,5	466,56
745-20-0457-112	450	453,0 - 460,0	457,2	16	7,1	518,42
745-20-0500-112	500	496,0 - 504,0	500,0	13	8,0	560,72
745-20-0508-112	500	504,0 - 512,0	508,0	13	7,7	563,22
745-20-0520-112	500	526,0 - 535,0	530,0	12	8,0	586,61
745-20-0558-112	550	555,0 - 563,0	558,8	12	8,3	607,96
745-20-0609-112	600	605,0 - 614,0	609,6	11	8,8	647,98
745-20-0616-112	600	612,0 - 621,0	616,0	11	8,0	660,94

745/20-113

Repico® S
Slip type coupling
Non-tensile / flexible
For all pipe types
Stainless steel
Silicone rubber



AVK ref. no.	DN mm	Tolerance mm	Pipe dia. mm	Working Pressure bar	Theoretical weight/kg	Gross Price EUR
745-20-0020-113	15	19,5 - 20,5	20,0	42	0.2	99.62
745-20-0021-113	15	21,0 - 22,0	21,3	42	0.2	101.17
745-20-0025-113	20	24,0 - 26,0	25,0	42	0.3	103.80
745-20-0027-113	20	26,0 - 28,0	26,7	42	0.3	105.34
745-20-0028-113	25	26,4 - 29,0	28,2	42	0.3	106.95
745-20-0030-113	25	29,0 - 31,0	30,0	42	0.3	108.57
745-20-0032-113	25	31,0 - 33,0	32,0	42	0.3	110.17
745-20-0034-113	25	33,0 - 35,0	33,4	42	0.3	111.83
745-20-0038-113	32	37,0 - 39,0	38,0	42	0.4	112.03
745-20-0040-113	32	39,5 - 41,3	40,0	42	0.4	113.19
745-20-0042-113	32	42,0 - 44,0	42,2	42	0.4	114.34
745-20-0044-113	32	44,0 - 46,0	44,5	42	0.4	115.45
745-20-0048-113	40	47,5 - 49,5	48,3	42	0.4	120.38
745-20-0050-113	50	49,2 - 51,5	50,8	42	0.4	126.81
745-20-0054-113	50	53,0 - 55,0	54,0	42	0.6	128.73
745-20-0057-113	50	56,0 - 58,0	57,0	42	0.6	130.67
745-20-0060-113	50	59,0 - 61,5	60,3	42	0.6	132.58
745-20-0063-113	50	62,0 - 64,0	63,0	42	0.6	134.59
745-20-0066-113	65	65,4 - 68,3	66,7	37	0.6	142.69
745-20-0069-113	65	68,5 - 71,0	69,0	37	0.7	143.41
745-20-0073-113	65	72,5 - 75,5	73,0	37	0.7	144.09
745-20-0076-113	65	75,0 - 78,0	76,1	37	0.7	144.81
745-20-0079-113	80	78,8 - 82,0	79,9	37	1.3	145.51
745-20-0084-113	80	82,5 - 85,5	84,0	37	1.3	147.71
745-20-0089-113	80	88,0 - 91,0	88,9	37	1.3	149.95
745-20-0101-113	100	100,0 - 103,0	101,6	37	1.4	152.20
745-20-0104-113	100	102,0 - 105,0	104,0	37	1.4	154.45
745-20-0106-113	100	105,0 - 107,0	106,3	37	1.4	156.76
745-20-0108-113	100	106,0 - 109,0	108,0	37	1.4	158.37
745-20-0114-113	100	113,0 - 116,0	114,3	37	1.4	160.74
745-20-0127-113	125	125,0 - 129,0	127,0	37	1.8	206.70
745-20-0129-113	125	127,5 - 130,0	129,0	37	1.8	209.79
745-20-0133-113	125	131,0 - 135,0	131,7	37	1.8	212.92
745-20-0139-113	125	138,0 - 142,0	139,7	37	1.9	216.15
745-20-0141-113	125	139,5 - 143,0	141,3	37	1.9	219.36
745-20-0154-113	150	151,5 - 155,0	154,0	32	2.0	228.88
745-20-0159-113	150	156,0 - 160,0	157,7	32	2.0	232.29
745-20-0165-113	150	164,0 - 167,0	165,2	32	2.1	235.75
745-20-0168-113	150	166,0 - 170,0	168,3	32	2.1	239.29
745-20-0180-113	175	178,0 - 182,0	180,0	26	2.2	247.38
745-20-0200-113	200	198,0 - 203,0	200,0	21	4.2	428.83
745-20-0204-113	200	202,0 - 206,0	204,0	21	4.2	435.32
745-20-0216-113	200	214,0 - 218,0	216,3	21	4.4	441.81
745-20-0219-113	200	216,5 - 221,0	219,1	21	4.4	448.44
745-20-0254-113	225	251,0 - 257,0	254,0	21	4.8	466.56
745-20-0267-113	250	262,0 - 269,0	267,4	21	5.0	473.57
745-20-0273-113	250	270,0 - 276,0	273,0	21	5.0	480.69
745-20-0304-113	300	301,5 - 308,0	304,0	18	5.4	499.53
745-20-0318-113	300	316,0 - 322,0	318,5	18	5.5	507.05
745-20-0323-113	300	322,0 - 328,0	323,9	18	5.6	514.63
745-20-0355-113	350	352,0 - 360,0	355,6	18	6.0	584.43
745-20-0406-113	400	402,0 - 410,0	406,4	16	6.5	645.63
745-20-0457-113	450	453,0 - 460,0	457,2	16	7.1	723.38
745-20-0508-113	500	504,0 - 512,0	508,0	13	7.7	784.65
745-20-0558-113	550	555,0 - 563,0	558,8	12	8.3	848.33
745-20-0609-113	600	605,0 - 614,0	609,6	11	8.8	911.91

745/20-114

Repico® S
Slip type coupling
Non-tensile / flexible
For all pipe types
Stainless steel



AVK ref. no.	DN mm	Tolerance mm	Pipe dia. mm	Working Pressure bar	Theoretical weight/kg	Gross Price EUR
745-20-0020-114	15	19,5 - 20,5	20,0	42	0.2	149.42
745-20-0021-114	15	21,0 - 22,0	21,3	42	0.2	151.68
745-20-0025-114	20	24,0 - 26,0	25,0	42	0.3	166.07
745-20-0027-114	20	26,0 - 28,0	26,7	42	0.3	168.58
745-20-0028-114	25	26,4 - 29,0	28,2	42	0.3	186.84
745-20-0030-114	25	29,0 - 31,0	30,0	42	0.3	189.59
745-20-0032-114	25	31,0 - 33,0	32,0	42	0.3	192.51
745-20-0034-114	25	33,0 - 35,0	33,4	42	0.3	195.32
745-20-0038-114	32	37,0 - 39,0	38,0	42	0.4	207.54
745-20-0040-114	32	39,5 - 41,3	40,0	42	0.4	209.59
745-20-0042-114	32	42,0 - 44,0	42,2	42	0.4	211.71
745-20-0044-114	32	44,0 - 46,0	44,5	42	0.4	213.83
745-20-0048-114	40	47,5 - 49,5	48,3	42	0.4	220.01
745-20-0050-114	50	49,2 - 51,5	50,8	42	0.4	223.35
745-20-0054-114	50	53,0 - 55,0	54,0	42	0.6	259.99
745-20-0057-114	50	56,0 - 58,0	57,0	42	0.6	263.84
745-20-0060-114	50	59,0 - 61,5	60,3	42	0.6	267.83
745-20-0063-114	50	62,0 - 64,0	63,0	42	0.6	271.81
745-20-0066-114	65	65,4 - 68,3	66,7	37	0.6	332.87
745-20-0069-114	65	68,5 - 71,0	69,0	37	0.7	334.55
745-20-0073-114	65	72,5 - 75,5	73,0	37	0.7	336.21
745-20-0076-114	65	75,0 - 78,0	76,1	37	0.7	337.87
745-20-0079-114	80	78,8 - 82,0	79,9	37	1.3	383.13
745-20-0084-114	80	82,5 - 85,5	84,0	37	1.3	388.93
745-20-0089-114	80	88,0 - 91,0	88,9	37	1.3	394.71
745-20-0101-114	100	100,0 - 103,0	101,6	37	1.4	435.06
745-20-0104-114	100	102,0 - 105,0	104,0	37	1.4	487.05
745-20-0106-114	100	105,0 - 107,0	106,3	37	1.4	494.33
745-20-0108-114	100	106,0 - 109,0	108,0	37	1.4	496.83
745-20-0114-114	100	113,0 - 116,0	114,3	37	1.4	499.34
745-20-0127-114	125	125,0 - 129,0	127,0	37	1.8	499.72
745-20-0129-114	125	127,5 - 130,0	129,0	37	1.8	507.25
745-20-0133-114	125	131,0 - 135,0	131,7	37	1.8	514.84
745-20-0139-114	125	138,0 - 142,0	139,7	37	1.9	522.53
745-20-0141-114	125	139,5 - 143,0	141,3	37	1.9	530.38
745-20-0154-114	150	151,5 - 155,0	154,0	32	2.0	704.04
745-20-0159-114	150	156,0 - 160,0	157,7	32	2.0	714.58
745-20-0165-114	150	164,0 - 167,0	165,2	32	2.1	725.31
745-20-0168-114	150	166,0 - 170,0	168,3	32	2.1	736.19
745-20-0180-114	175	178,0 - 182,0	180,0	26	2.2	761.12
745-20-0200-114	200	198,0 - 203,0	200,0	21	4.2	1,345.56
745-20-0204-114	200	202,0 - 206,0	204,0	21	4.2	1,365.73
745-20-0216-114	200	214,0 - 218,0	216,3	21	4.4	1,386.23
745-20-0219-114	200	216,5 - 221,0	219,1	21	4.4	1,407.00
745-20-0254-114	225	251,0 - 257,0	254,0	21	4.8	1,428.08
745-20-0267-114	250	262,0 - 269,0	267,4	21	5.0	1,564.65
745-20-0273-114	250	270,0 - 276,0	273,0	21	5.0	1,588.12
745-20-0304-114	300	301,5 - 308,0	304,0	18	5.4	1,611.96
745-20-0318-114	300	316,0 - 322,0	318,5	18	5.5	1,790.89
745-20-0323-114	300	322,0 - 328,0	323,9	18	5.6	1,817.78
745-20-0355-114	350	352,0 - 360,0	355,6	18	6.0	2,151.41
745-20-0406-114	400	402,0 - 410,0	406,4	16	6.5	2,488.38
745-20-0457-114	450	453,0 - 460,0	457,2	16	7.1	2,785.25
745-20-0508-114	500	504,0 - 512,0	508,0	13	7.7	3,068.06
745-20-0558-114	550	555,0 - 563,0	558,8	12	8.3	3,353.19
745-20-0609-114	600	605,0 - 614,0	609,6	11	8.8	3,647.73

745/28-111

Repico® SD
 Slip type coupling with two
 locks
 Flexible / non-tensile restraint
 For all pipe types
 Stainless steel
 EPDM drinking water
 approved



AVK ref. no.	DN mm	Tolerance mm	Pipe dia. mm	Working Pressure bar	Theoretical weight/kg	Gross Price EUR
745-28-0015-111	15	15,3 - 17,0	15,5	42	0.3	182.72
745-28-0020-111	15	19,5 - 21,3	20,0	42	0.3	183.63
745-28-0021-111	15	21,0 - 23,0	21,3	42	0.3	184.52
745-28-0025-111	20	24,0 - 26,5	25,0	42	0.5	185.48
745-28-0027-111	20	26,0 - 28,5	26,7	42	0.5	186.39
745-28-0028-111	25	26,4 - 29,5	28,2	42	0.5	188.26
745-28-0030-111	25	29,0 - 31,5	30,0	42	0.5	189.22
745-28-0032-111	25	31,0 - 33,5	32,0	42	0.5	190.13
745-28-0034-111	25	33,0 - 35,5	33,4	42	0.5	190.90
745-28-0038-111	32	37,0 - 39,5	38,0	42	0.6	190.96
745-28-0040-111	32	39,5 - 41,8	40,0	42	0.6	191.91
745-28-0042-111	32	42,0 - 44,5	42,2	42	0.6	192.89
745-28-0044-111	32	44,0 - 46,5	44,5	42	0.6	193.06
745-28-0048-111	40	47,5 - 50,5	48,3	42	0.6	193.73
745-28-0050-111	50	49,2 - 51,5	50,8	42	0.6	224.05
745-28-0054-111	50	53,0 - 56,0	54,0	42	0.9	225.14
745-28-0057-111	50	56,0 - 59,0	57,0	42	0.9	226.30
745-28-0060-111	50	59,0 - 62,0	60,3	42	0.9	227.40
745-28-0063-111	50	62,0 - 65,0	63,0	42	0.9	228.54
745-28-0066-111	65	65,4 - 69,0	66,7	37	0.9	232.54
745-28-0069-111	65	68,5 - 72,0	69,0	37	1.0	236.01
745-28-0073-111	65	72,5 - 76,5	73,0	37	1.0	239.54
745-28-0076-111	65	75,0 - 79,0	76,1	37	1.0	243.15
745-28-0079-111	80	78,8 - 83,0	79,9	37	2.0	247.25
745-28-0084-111	80	82,5 - 86,0	84,0	37	2.0	251.00
745-28-0089-111	80	88,0 - 92,0	88,9	37	2.0	254.71
745-28-0101-111	100	100,0 - 104,0	101,6	37	2.1	255.43
745-28-0104-111	100	102,0 - 106,0	104,0	37	2.1	266.27
745-28-0106-111	100	105,0 - 108,0	106,3	37	2.1	270.27
745-28-0108-111	100	106,0 - 110,0	108,0	37	2.1	274.38
745-28-0114-111	100	113,0 - 118,0	114,3	37	2.2	278.49
745-28-0127-111	125	125,0 - 129,0	127,0	37	2.6	330.11
745-28-0129-111	125	127,5 - 131,0	129,0	37	2.6	335.05
745-28-0133-111	125	131,0 - 135,0	131,7	37	2.6	340.06
745-28-0139-111	125	138,0 - 142,0	139,7	37	2.7	345.15
745-28-0141-111	125	139,5 - 144,0	141,3	37	2.7	350.35
745-28-0154-111	150	151,5 - 156,0	154,0	32	2.8	354.54
745-28-0159-111	150	156,0 - 161,0	157,7	32	2.8	359.87
745-28-0165-111	150	164,0 - 168,0	165,2	32	2.9	365.26
745-28-0168-111	150	166,0 - 170,0	168,3	32	2.9	370.72
745-28-0180-111	175	178,0 - 183,0	180,0	26	3.0	383.32
745-28-0200-111	200	198,0 - 203,0	200,0	21	5.9	669.21
745-28-0204-111	200	202,0 - 206,0	204,0	21	5.9	679.24
745-28-0216-111	200	214,0 - 219,0	216,3	21	6.1	689.47
745-28-0219-111	200	216,5 - 222,0	219,1	21	6.1	699.81
745-28-0254-111	225	251,0 - 257,0	254,0	21	6.5	722.61
745-28-0267-111	250	262,0 - 270,0	267,4	21	6.6	733.48
745-28-0273-111	250	270,0 - 277,0	273,0	21	6.7	744.48
745-28-0304-111	300	301,5 - 309,0	304,0	18	7.0	772.89
745-28-0318-111	300	316,0 - 323,0	318,5	18	7.2	784.51
745-28-0323-111	300	322,0 - 329,0	323,9	18	7.3	796.27
745-28-0355-111	350	352,0 - 361,0	355,6	18	7.6	857.72
745-28-0406-111	400	402,0 - 411,0	406,4	16	8.3	911.14
745-28-0457-111	450	453,0 - 462,0	457,2	16	8.9	964.54
745-28-0508-111	500	504,0 - 513,0	508,0	13	9.4	1,021.17
745-28-0558-111	550	555,0 - 564,0	558,8	12	10	1,071.43
745-28-0609-111	600	605,0 - 615,0	609,6	11	11	1,121.62
745-28-0660-111	650	654,0 - 666,0	660,4	10	11	1,178.19
745-28-0711-111	700	705,0 - 717,0	711,2	9	12	1,231.66
745-28-0762-111	750	756,0 - 768,0	762,0	9	12	1,250.11
745-28-0812-111	800	806,0 - 818,0	812,8	9	13	1,341.56
745-28-0863-111	850	857,0 - 869,0	863,6	8	13	1,361.68
745-28-0914-111	900	906,0 - 920,0	914,4	8	14	1,382.12
745-28-1016-111	1000	1010,0 - 1022,0	1016,0	7	15	1,611.77

745/28-112

Repico® SD
 Slip type coupling with two
 locks
 Non-tensile / flexible
 For all pipe types
 Stainless steel
 NBR rubber



AVK ref. no.	DN mm	Tolerance mm	Pipe dia. mm	Working Pressure bar	Theoretical weight/kg	Gross Price EUR
745-28-0015-112	15	15,3 - 17,0	15,5	42	0.3	182.72
745-28-0020-112	15	19,5 - 21,3	20,0	42	0.3	183.63
745-28-0021-112	15	21,0 - 23,0	21,3	42	0.3	184.52
745-28-0025-112	20	24,0 - 26,5	25,0	42	0.5	185.48
745-28-0027-112	20	26,0 - 28,5	26,7	42	0.5	186.39
745-28-0028-112	25	26,4 - 29,5	28,2	42	0.5	188.26
745-28-0030-112	25	29,0 - 31,5	30,0	42	0.5	189.22
745-28-0032-112	25	31,0 - 33,5	32,0	42	0.5	190.13
745-28-0034-112	25	33,0 - 35,5	33,4	42	0.5	190.90
745-28-0038-112	32	37,0 - 39,5	38,0	42	0.6	190.96
745-28-0040-112	32	39,5 - 41,8	40,0	42	0.6	191.91
745-28-0042-112	32	42,0 - 44,5	42,2	42	0.6	192.89
745-28-0044-112	32	44,0 - 46,5	44,5	42	0.6	193.06
745-28-0048-112	40	47,5 - 50,5	48,3	42	0.6	193.73
745-28-0050-112	50	49,2 - 51,5	50,8	42	0.6	224.05
745-28-0054-112	50	53,0 - 56,0	54,0	42	0.9	225.14
745-28-0057-112	50	56,0 - 59,0	57,0	42	0.9	226.30
745-28-0060-112	50	59,0 - 62,0	60,3	42	0.9	227.40
745-28-0063-112	50	62,0 - 65,0	63,0	42	0.9	228.54
745-28-0066-112	65	65,4 - 69,0	66,7	37	0.9	232.54
745-28-0069-112	65	68,5 - 72,0	69,0	37	1.0	236.01
745-28-0073-112	65	72,5 - 76,5	73,0	37	1.0	239.54
745-28-0076-112	65	75,0 - 79,0	76,1	37	1.0	243.15
745-28-0079-112	80	78,8 - 83,0	79,9	37	2.0	247.25
745-28-0084-112	80	82,5 - 86,0	84,0	37	2.0	251.00
745-28-0089-112	80	88,0 - 92,0	88,9	37	2.0	254.71
745-28-0101-112	100	100,0 - 104,0	101,6	37	2.1	255.43
745-28-0104-112	100	102,0 - 106,0	104,0	37	2.1	266.27
745-28-0106-112	100	105,0 - 108,0	106,3	37	2.1	270.27
745-28-0108-112	100	106,0 - 110,0	108,0	37	2.1	274.38
745-28-0114-112	100	113,0 - 118,0	114,3	37	2.2	278.49
745-28-0127-112	125	125,0 - 129,0	127,0	37	2.6	330.11
745-28-0129-112	125	127,5 - 131,0	129,0	37	2.6	335.05
745-28-0133-112	125	131,0 - 135,0	131,7	37	2.6	340.06
745-28-0139-112	125	138,0 - 142,0	139,7	37	2.7	345.15
745-28-0141-112	125	139,5 - 144,0	141,3	37	2.7	350.35
745-28-0154-112	150	151,5 - 156,0	154,0	32	2.8	354.54
745-28-0159-112	150	156,0 - 161,0	157,7	32	2.8	359.87
745-28-0165-112	150	164,0 - 168,0	165,2	32	2.9	365.26
745-28-0168-112	150	166,0 - 170,0	168,3	32	2.9	370.72
745-28-0180-112	175	178,0 - 183,0	180,0	26	3.0	383.32
745-28-0200-112	200	198,0 - 203,0	200,0	21	5.9	669.21
745-28-0204-112	200	202,0 - 206,0	204,0	21	5.9	679.24
745-28-0216-112	200	214,0 - 219,0	216,3	21	6.1	689.47
745-28-0219-112	200	216,5 - 222,0	219,1	21	6.1	699.81
745-28-0254-112	225	251,0 - 257,0	254,0	21	6.5	722.61
745-28-0267-112	250	262,0 - 270,0	267,4	21	6.6	733.48
745-28-0273-112	250	270,0 - 277,0	273,0	21	6.7	744.48
745-28-0304-112	300	301,5 - 309,0	304,0	18	7.0	772.89
745-28-0318-112	300	316,0 - 323,0	318,5	18	7.2	784.51
745-28-0323-112	300	322,0 - 329,0	323,9	18	7.3	796.27
745-28-0355-112	350	352,0 - 361,0	355,6	18	7.6	857.72
745-28-0406-112	400	402,0 - 411,0	406,4	16	8.3	911.14
745-28-0457-112	450	453,0 - 462,0	457,2	16	8.9	964.54
745-28-0508-112	500	504,0 - 513,0	508,0	13	9.4	1,021.17
745-28-0558-112	550	555,0 - 564,0	558,8	12	10	1,071.43
745-28-0609-112	600	605,0 - 615,0	609,6	11	11	1,121.62
745-28-0660-112	650	654,0 - 666,0	660,4	10	11	1,178.19
745-28-0711-112	700	705,0 - 717,0	711,2	9	12	1,231.66
745-28-0762-112	750	756,0 - 768,0	762,0	9	12	1,250.11
745-28-0812-112	800	806,0 - 818,0	812,8	9	13	1,341.56
745-28-0863-112	850	857,0 - 869,0	863,6	8	13	1,361.68
745-28-0914-112	900	906,0 - 920,0	914,4	8	14	1,382.12
745-28-1016-112	1000	1010,0 - 1022,0	1016,0	7	15	1,611.77

745/28-113

Repico® SD
 Slip type coupling with two
 locks
 non-tensile / flexible
 For all pipe types
 Stainless steel
 Silicone rubber



AVK ref. no.	DN mm	Tolerance mm	Pipe dia. mm	Working Pressure bar	Theoretical weight/kg	Gross Price EUR
745-28-0015-113	15	15,3 - 17,0	15,5	42	0.3	193.73
745-28-0020-113	15	19,5 - 21,3	20,0	42	0.3	194.67
745-28-0021-113	15	21,0 - 23,0	21,3	42	0.3	195.65
745-28-0025-113	20	24,0 - 26,5	25,0	42	0.5	204.77
745-28-0027-113	20	26,0 - 28,5	26,7	42	0.5	205.81
745-28-0028-113	25	26,4 - 29,5	28,2	42	0.5	206.82
745-28-0030-113	25	29,0 - 31,5	30,0	42	0.5	207.85
745-28-0032-113	25	31,0 - 33,5	32,0	42	0.5	208.96
745-28-0034-113	25	33,0 - 35,5	33,4	42	0.5	209.98
745-28-0038-113	32	37,0 - 39,5	38,0	42	0.6	210.36
745-28-0040-113	32	39,5 - 41,8	40,0	42	0.6	211.40
745-28-0042-113	32	42,0 - 44,5	42,2	42	0.6	212.49
745-28-0044-113	32	44,0 - 46,5	44,5	42	0.6	212.67
745-28-0048-113	40	47,5 - 50,5	48,3	42	0.6	215.90
745-28-0050-113	50	49,2 - 51,5	50,8	42	0.6	262.11
745-28-0054-113	50	53,0 - 56,0	54,0	42	0.9	263.38
745-28-0057-113	50	56,0 - 59,0	57,0	42	0.9	264.74
745-28-0060-113	50	59,0 - 62,0	60,3	42	0.9	266.03
745-28-0063-113	50	62,0 - 65,0	63,0	42	0.9	267.38
745-28-0066-113	65	65,4 - 69,0	66,7	37	0.9	278.95
745-28-0069-113	65	68,5 - 72,0	69,0	37	1.0	279.78
745-28-0073-113	65	72,5 - 76,5	73,0	37	1.0	280.93
745-28-0076-113	65	75,0 - 79,0	76,1	37	1.0	282.35
745-28-0079-113	80	78,8 - 83,0	79,9	37	2.0	282.61
745-28-0084-113	80	82,5 - 86,0	84,0	37	2.0	286.86
745-28-0089-113	80	88,0 - 92,0	88,9	37	2.0	291.16
745-28-0101-113	100	100,0 - 104,0	101,6	37	2.1	293.47
745-28-0104-113	100	102,0 - 106,0	104,0	37	2.1	313.72
745-28-0106-113	100	105,0 - 108,0	106,3	37	2.1	318.42
745-28-0108-113	100	106,0 - 110,0	108,0	37	2.1	323.17
745-28-0114-113	100	113,0 - 118,0	114,3	37	2.2	328.06
745-28-0127-113	125	125,0 - 129,0	127,0	37	2.6	387.51
745-28-0129-113	125	127,5 - 131,0	129,0	37	2.6	393.28
745-28-0133-113	125	131,0 - 135,0	131,7	37	2.6	399.20
745-28-0139-113	125	138,0 - 142,0	139,7	37	2.7	405.17
745-28-0141-113	125	139,5 - 144,0	141,3	37	2.7	411.28
745-28-0154-113	150	151,5 - 156,0	154,0	32	2.8	427.22
745-28-0159-113	150	156,0 - 161,0	157,7	32	2.8	433.66
745-28-0165-113	150	164,0 - 168,0	165,2	32	2.9	440.15
745-28-0168-113	150	166,0 - 170,0	168,3	32	2.9	446.77
745-28-0180-113	175	178,0 - 183,0	180,0	26	3.0	461.87
745-28-0200-113	200	198,0 - 203,0	200,0	21	5.9	829.51
745-28-0204-113	200	202,0 - 206,0	204,0	21	5.9	841.90
745-28-0216-113	200	214,0 - 219,0	216,3	21	6.1	854.56
745-28-0219-113	200	216,5 - 222,0	219,1	21	6.1	867.36
745-28-0254-113	225	251,0 - 257,0	254,0	21	6.5	892.29
745-28-0267-113	250	262,0 - 270,0	267,4	21	6.6	905.67
745-28-0273-113	250	270,0 - 277,0	273,0	21	6.7	919.29
745-28-0304-113	300	301,5 - 309,0	304,0	18	7.0	951.95
745-28-0318-113	300	316,0 - 323,0	318,5	18	7.2	966.20
745-28-0323-113	300	322,0 - 329,0	323,9	18	7.3	980.73
745-28-0355-113	350	352,0 - 361,0	355,6	18	7.6	1,061.98
745-28-0406-113	400	402,0 - 411,0	406,4	16	8.3	1,159.35
745-28-0457-113	450	453,0 - 462,0	457,2	16	8.9	1,247.35
745-28-0508-113	500	504,0 - 513,0	508,0	13	9.4	1,335.33
745-28-0558-113	550	555,0 - 564,0	558,8	12	10	1,416.96
745-28-0609-113	600	605,0 - 615,0	609,6	11	11	1,498.70
745-28-0660-113	650	654,0 - 666,0	660,4	10	11	1,586.64
745-28-0711-113	700	705,0 - 717,0	711,2	9	12	1,671.48
745-28-0762-113	750	756,0 - 768,0	762,0	9	12	1,696.61
745-28-0812-113	800	806,0 - 818,0	812,8	9	13	1,844.24
745-28-0863-113	850	857,0 - 869,0	863,6	8	13	1,871.96
745-28-0914-113	900	906,0 - 920,0	914,4	8	14	1,900.02
745-28-1016-113	1000	1010,0 - 1022,0	1016,0	7	15	2,227.62

745/28-114

Repico® SD
 Slip type coupling with two
 locks
 Non-tensile / flexible
 For all pipe types
 Stainless steel



AVK ref. no.	DN mm	Tolerance mm	Pipe dia. mm	Working Pressure bar	Theoretical weight/kg	Gross Price EUR
745-28-0015-114	15	15,3 - 17,0	15,5	42	0.3	282.27
745-28-0020-114	15	19,5 - 21,3	20,0	42	0.3	283.70
745-28-0021-114	15	21,0 - 23,0	21,3	42	0.3	285.12
745-28-0025-114	20	24,0 - 26,5	25,0	42	0.5	286.53
745-28-0027-114	20	26,0 - 28,5	26,7	42	0.5	287.94
745-28-0028-114	25	26,4 - 29,5	28,2	42	0.5	310.06
745-28-0030-114	25	29,0 - 31,5	30,0	42	0.5	311.59
745-28-0032-114	25	31,0 - 33,5	32,0	42	0.5	313.14
745-28-0034-114	25	33,0 - 35,5	33,4	42	0.5	314.69
745-28-0038-114	32	37,0 - 39,5	38,0	42	0.6	337.70
745-28-0040-114	32	39,5 - 41,8	40,0	42	0.6	339.36
745-28-0042-114	32	42,0 - 44,5	42,2	42	0.6	341.04
745-28-0044-114	32	44,0 - 46,5	44,5	42	0.6	341.42
745-28-0048-114	40	47,5 - 50,5	48,3	42	0.6	348.75
745-28-0050-114	50	49,2 - 51,5	50,8	42	0.6	354.02
745-28-0054-114	50	53,0 - 56,0	54,0	42	0.9	355.75
745-28-0057-114	50	56,0 - 59,0	57,0	42	0.9	357.55
745-28-0060-114	50	59,0 - 62,0	60,3	42	0.9	359.35
745-28-0063-114	50	62,0 - 65,0	63,0	42	0.9	361.15
745-28-0066-114	65	65,4 - 69,0	66,7	37	0.9	558.01
745-28-0069-114	65	68,5 - 72,0	69,0	37	1.0	566.36
745-28-0073-114	65	72,5 - 76,5	73,0	37	1.0	574.85
745-28-0076-114	65	75,0 - 79,0	76,1	37	1.0	583.54
745-28-0079-114	80	78,8 - 83,0	79,9	37	2.0	638.55
745-28-0084-114	80	82,5 - 86,0	84,0	37	2.0	648.13
745-28-0089-114	80	88,0 - 92,0	88,9	37	2.0	657.83
745-28-0101-114	100	100,0 - 104,0	101,6	37	2.1	717.36
745-28-0104-114	100	102,0 - 106,0	104,0	37	2.1	793.39
745-28-0106-114	100	105,0 - 108,0	106,3	37	2.1	805.26
745-28-0108-114	100	106,0 - 110,0	108,0	37	2.1	817.37
745-28-0114-114	100	113,0 - 118,0	114,3	37	2.2	829.64
745-28-0127-114	125	125,0 - 129,0	127,0	37	2.6	833.82
745-28-0129-114	125	127,5 - 131,0	129,0	37	2.6	846.27
745-28-0133-114	125	131,0 - 135,0	131,7	37	2.6	858.99
745-28-0139-114	125	138,0 - 142,0	139,7	37	2.7	871.85
745-28-0141-114	125	139,5 - 144,0	141,3	37	2.7	884.96
745-28-0154-114	150	151,5 - 156,0	154,0	32	2.8	1,156.65
745-28-0159-114	150	156,0 - 161,0	157,7	32	2.8	1,174.00
745-28-0165-114	150	164,0 - 168,0	165,2	32	2.9	1,191.61
745-28-0168-114	150	166,0 - 170,0	168,3	32	2.9	1,209.49
745-28-0180-114	175	178,0 - 183,0	180,0	26	3.0	1,250.49
745-28-0200-114	200	198,0 - 203,0	200,0	21	5.9	2,067.32
745-28-0204-114	200	202,0 - 206,0	204,0	21	5.9	2,077.68
745-28-0216-114	200	214,0 - 219,0	216,3	21	6.1	2,108.86
745-28-0219-114	200	216,5 - 222,0	219,1	21	6.1	2,140.47
745-28-0254-114	225	251,0 - 257,0	254,0	21	6.5	2,151.21
745-28-0267-114	250	262,0 - 270,0	267,4	21	6.6	2,402.59
745-28-0273-114	250	270,0 - 277,0	273,0	21	6.7	2,438.63
745-28-0304-114	300	301,5 - 309,0	304,0	18	7.0	2,450.84
745-28-0318-114	300	316,0 - 323,0	318,5	18	7.2	2,487.62
745-28-0323-114	300	322,0 - 329,0	323,9	18	7.3	2,814.76
745-28-0355-114	350	352,0 - 361,0	355,6	18	7.6	3,333.51
745-28-0406-114	400	402,0 - 411,0	406,4	16	8.3	3,746.65
745-28-0457-114	450	453,0 - 462,0	457,2	16	8.9	3,996.49
745-28-0508-114	500	504,0 - 513,0	508,0	13	9.4	4,376.65
745-28-0558-114	550	555,0 - 564,0	558,8	12	10	4,621.73
745-28-0609-114	600	605,0 - 615,0	609,6	11	11	5,014.43
745-28-0660-114	650	654,0 - 666,0	660,4	10	11	5,275.27
745-28-0711-114	700	705,0 - 717,0	711,2	9	12	5,617.70
745-28-0762-114	750	756,0 - 768,0	762,0	9	12	5,701.95
745-28-0812-114	800	806,0 - 818,0	812,8	9	13	6,312.03
745-28-0863-114	850	857,0 - 869,0	863,6	8	13	6,406.71
745-28-0914-114	900	906,0 - 920,0	914,4	8	14	6,502.87
745-28-1016-114	1000	1010,0 - 1022,0	1016,0	7	15	7,738.50

745/29-111

Repico® SDL
 Slip type coupling with two
 locks long version
 Non-tensile / flexible
 For all pipe types
 Stainless steel
 EPDM drinking water
 approved



AVK ref. no.	DN mm	Tolerance mm	Pipe dia. mm	Working Pressure bar	Theoretical weight/kg	Gross Price EUR
745-29-0020-111	15	19,5 - 21,3	20,0	42	0.5	260.18
745-29-0021-111	15	21,0 - 23,0	21,3	42	0.5	264.09
745-29-0025-111	20	24,0 - 26,5	25,0	42	0.6	264.43
745-29-0027-111	20	26,0 - 28,5	26,7	42	0.6	265.51
745-29-0032-111	25	31,0 - 33,5	32,0	42	0.6	265.77
745-29-0034-111	25	33,0 - 35,5	33,4	42	0.6	269.76
745-29-0040-111	32	39,5 - 41,8	40,0	42	0.6	271.16
745-29-0042-111	32	42,0 - 44,5	42,2	42	0.6	275.28
745-29-0048-111	40	47,5 - 50,5	48,3	42	0.7	276.76
745-29-0050-111	50	49,2 - 51,5	50,8	42	0.7	338.21
745-29-0060-111	50	59,0 - 62,0	60,3	42	1.7	343.29
745-29-0063-111	50	62,0 - 65,0	63,0	42	1.7	348.42
745-29-0069-111	65	68,5 - 72,0	69,0	37	1.8	350.87
745-29-0073-111	65	72,5 - 76,5	73,0	37	1.8	356.14
745-29-0076-111	65	75,0 - 79,0	76,1	37	1.8	361.47
745-29-0089-111	80	88,0 - 92,0	88,9	37	3.6	392.20
745-29-0101-111	100	100,0 - 104,0	101,6	37	3.7	406.14
745-29-0104-111	100	102,0 - 106,0	104,0	37	3.8	420.14
745-29-0106-111	100	105,0 - 108,0	106,3	37	3.8	426.46
745-29-0108-111	100	106,0 - 110,0	108,0	37	3.8	432.88
745-29-0114-111	100	113,0 - 118,0	114,3	37	3.9	439.38
745-29-0139-111	125	138,0 - 142,0	139,7	37	4.8	519.51
745-29-0141-111	125	139,5 - 144,0	141,3	37	4.8	527.29
745-29-0159-111	150	156,0 - 161,0	157,7	32	5.1	560.91
745-29-0165-111	150	164,0 - 168,0	165,2	32	5.2	569.34
745-29-0168-111	150	166,0 - 170,0	168,3	32	5.2	577.87
745-29-0216-111	200	214,0 - 219,0	216,3	21	13	1,197.08
745-29-0219-111	200	216,5 - 222,0	219,1	21	13	1,215.08
745-29-0267-111	250	262,0 - 270,0	267,4	21	14	1,266.16
745-29-0273-111	250	270,0 - 277,0	273,0	21	14	1,285.13
745-29-0318-111	300	316,0 - 323,0	318,5	18	15	1,338.42
745-29-0323-111	300	322,0 - 329,0	323,9	18	15	1,358.47
745-29-0355-111	350	352,0 - 361,0	355,6	18	16	1,520.70
745-29-0406-111	400	402,0 - 411,0	406,4	16	17	1,608.62
745-29-0457-111	450	453,0 - 462,0	457,2	16	18	1,696.66
745-29-0508-111	500	504,0 - 513,0	508,0	13	19	1,784.60
745-29-0558-111	550	555,0 - 564,0	558,8	12	20	1,872.52
745-29-0609-111	600	605,0 - 615,0	609,6	11	21	1,963.66
745-29-0660-111	650	654,0 - 666,0	660,4	10	22	2,064.18
745-29-0711-111	700	705,0 - 717,0	711,2	9	23	2,158.47
745-29-0762-111	750	756,0 - 768,0	762,0	9	24	2,190.80
745-29-0812-111	800	806,0 - 818,0	812,8	9	25	2,353.29
745-29-0863-111	850	857,0 - 869,0	863,6	8	26	2,388.56
745-29-0914-111	900	906,0 - 920,0	914,4	8	27	2,424.37
745-29-1016-111	1000	1010,0 - 1022,0	1016,0	7	29	2,736.53

745/29-112

Repico® SDL
 Slip type coupling with two
 locks long version
 Non-tensile / flexible
 For all pipe types
 Stainless steel
 NBR rubber



AVK ref. no.	DN mm	Tolerance mm	Pipe dia. mm	Working Pressure bar	Theoretical weight/kg	Gross Price EUR
745-29-0020-112	15	19,5 - 21,3	20,0	42	0.5	260.18
745-29-0021-112	15	21,0 - 23,0	21,3	42	0.5	264.09
745-29-0025-112	20	24,0 - 26,5	25,0	42	0.6	264.43
745-29-0027-112	20	26,0 - 28,5	26,7	42	0.6	265.51
745-29-0032-112	25	31,0 - 33,5	32,0	42	0.6	265.77
745-29-0034-112	25	33,0 - 35,5	33,4	42	0.6	269.76
745-29-0040-112	32	39,5 - 41,8	40,0	42	0.6	271.16
745-29-0042-112	32	42,0 - 44,5	42,2	42	0.6	275.28
745-29-0048-112	40	47,5 - 50,5	48,3	42	0.7	276.76
745-29-0050-112	50	49,2 - 51,5	50,8	42	0.7	338.21
745-29-0060-112	50	59,0 - 62,0	60,3	42	1.7	343.29
745-29-0063-112	50	62,0 - 65,0	63,0	42	1.7	348.42
745-29-0069-112	65	68,5 - 72,0	69,0	37	1.8	350.87
745-29-0073-112	65	72,5 - 76,5	73,0	37	1.8	356.14
745-29-0076-112	65	75,0 - 79,0	76,1	37	1.8	361.47
745-29-0089-112	80	88,0 - 92,0	88,9	37	3.6	392.20
745-29-0101-112	100	100,0 - 104,0	101,6	37	3.7	406.14
745-29-0104-112	100	102,0 - 106,0	104,0	37	3.8	420.14
745-29-0106-112	100	105,0 - 108,0	106,3	37	3.8	426.46
745-29-0108-112	100	106,0 - 110,0	108,0	37	3.8	432.88
745-29-0114-112	100	113,0 - 118,0	114,3	37	3.9	439.38
745-29-0139-112	125	138,0 - 142,0	139,7	37	4.8	519.51
745-29-0141-112	125	139,5 - 144,0	141,3	37	4.8	527.29
745-29-0159-112	150	156,0 - 161,0	157,7	32	5.1	560.91
745-29-0165-112	150	164,0 - 168,0	165,2	32	5.2	569.34
745-29-0168-112	150	166,0 - 170,0	168,3	32	5.2	577.87
745-29-0216-112	200	214,0 - 219,0	216,3	21	13	1,197.08
745-29-0219-112	200	216,5 - 222,0	219,1	21	13	1,215.08
745-29-0267-112	250	262,0 - 270,0	267,4	21	14	1,266.16
745-29-0273-112	250	270,0 - 277,0	273,0	21	14	1,285.13
745-29-0318-112	300	316,0 - 323,0	318,5	18	15	1,338.42
745-29-0323-112	300	322,0 - 329,0	323,9	18	15	1,358.47
745-29-0355-112	350	352,0 - 361,0	355,6	18	16	1,520.70
745-29-0406-112	400	402,0 - 411,0	406,4	16	17	1,608.62
745-29-0457-112	450	453,0 - 462,0	457,2	16	18	1,696.66
745-29-0508-112	500	504,0 - 513,0	508,0	13	19	1,784.60
745-29-0558-112	550	555,0 - 564,0	558,8	12	20	1,872.52
745-29-0609-112	600	605,0 - 615,0	609,6	11	21	1,963.66
745-29-0660-112	650	654,0 - 666,0	660,4	10	22	2,064.18
745-29-0711-112	700	705,0 - 717,0	711,2	9	23	2,158.47
745-29-0762-112	750	756,0 - 768,0	762,0	9	24	2,190.80
745-29-0812-112	800	806,0 - 818,0	812,8	9	25	2,353.29
745-29-0863-112	850	857,0 - 869,0	863,6	8	26	2,388.56
745-29-0914-112	900	906,0 - 920,0	914,4	8	27	2,424.37
745-29-1016-112	1000	1010,0 - 1022,0	1016,0	7	29	2,736.53

745/29-113

Repico® SDL
 Slip type coupling with two
 locks long version
 Non-tensile / flexible
 For all pipe types
 Stainless steel
 Silicone rubber



AVK ref. no.	DN mm	Tolerance mm	Pipe dia. mm	Working Pressure bar	Theoretical weight/kg	Gross Price EUR
745-29-0020-113	15	19,5 - 21,3	20,0	42	0.5	265.77
745-29-0021-113	15	21,0 - 23,0	21,3	42	0.5	269.76
745-29-0025-113	20	24,0 - 26,5	25,0	42	0.6	287.81
745-29-0027-113	20	26,0 - 28,5	26,7	42	0.6	288.97
745-29-0032-113	25	31,0 - 33,5	32,0	42	0.6	293.40
745-29-0034-113	25	33,0 - 35,5	33,4	42	0.6	294.82
745-29-0040-113	32	39,5 - 41,8	40,0	42	0.6	296.30
745-29-0042-113	32	42,0 - 44,5	42,2	42	0.6	297.20
745-29-0048-113	40	47,5 - 50,5	48,3	42	0.7	298.93
745-29-0050-113	50	49,2 - 51,5	50,8	42	0.7	422.72
745-29-0060-113	50	59,0 - 62,0	60,3	42	1.7	429.09
745-29-0063-113	50	62,0 - 65,0	63,0	42	1.7	435.51
745-29-0069-113	65	68,5 - 72,0	69,0	37	1.8	452.29
745-29-0073-113	65	72,5 - 76,5	73,0	37	1.8	459.10
745-29-0076-113	65	75,0 - 79,0	76,1	37	1.8	465.98
745-29-0089-113	80	88,0 - 92,0	88,9	37	3.6	470.02
745-29-0101-113	100	100,0 - 104,0	101,6	37	3.7	486.35
745-29-0104-113	100	102,0 - 106,0	104,0	37	3.8	502.68
745-29-0106-113	100	105,0 - 108,0	106,3	37	3.8	510.26
745-29-0108-113	100	106,0 - 110,0	108,0	37	3.8	517.91
745-29-0114-113	100	113,0 - 118,0	114,3	37	3.9	525.69
745-29-0139-113	125	138,0 - 142,0	139,7	37	4.8	620.03
745-29-0141-113	125	139,5 - 144,0	141,3	37	4.8	629.30
745-29-0159-113	150	156,0 - 161,0	157,7	32	5.1	677.19
745-29-0165-113	150	164,0 - 168,0	165,2	32	5.2	687.33
745-29-0168-113	150	166,0 - 170,0	168,3	32	5.2	697.63
745-29-0216-113	200	214,0 - 219,0	216,3	21	13	1,432.70
745-29-0219-113	200	216,5 - 222,0	219,1	21	13	1,454.23
745-29-0267-113	250	262,0 - 270,0	267,4	21	14	1,530.08
745-29-0273-113	250	270,0 - 277,0	273,0	21	14	1,553.02
745-29-0318-113	300	316,0 - 323,0	318,5	18	15	1,630.60
745-29-0323-113	300	322,0 - 329,0	323,9	18	15	1,655.09
745-29-0355-113	350	352,0 - 361,0	355,6	18	16	1,866.29
745-29-0406-113	400	402,0 - 411,0	406,4	16	17	1,973.10
745-29-0457-113	450	453,0 - 462,0	457,2	16	18	2,098.64
745-29-0508-113	500	504,0 - 513,0	508,0	13	19	2,218.12
745-29-0558-113	550	555,0 - 564,0	558,8	12	20	2,343.90
745-29-0609-113	600	605,0 - 615,0	609,6	11	21	2,475.77
745-29-0660-113	650	654,0 - 666,0	660,4	10	22	2,607.81
745-29-0711-113	700	705,0 - 717,0	711,2	9	23	2,739.69
745-29-0762-113	750	756,0 - 768,0	762,0	9	24	2,780.81
745-29-0812-113	800	806,0 - 818,0	812,8	9	25	3,006.81
745-29-0863-113	850	857,0 - 869,0	863,6	8	26	3,051.87
745-29-0914-113	900	906,0 - 920,0	914,4	8	27	3,097.62
745-29-1016-113	1000	1010,0 - 1022,0	1016,0	7	29	3,531.46

745/32-111

Repico® SDF
 Slip type coupling with two
 locks for high pressure
 Non-tensile / flexible
 For all pipe types
 Stainless steel
 EPDM drinking water
 approved



AVK ref. no.	DN mm	Tolerance mm	Pipe dia. mm	Working Pressure bar	Theoretical weight/kg	Gross Price EUR
745-32-0076-111	65	75,0 - 79,0	76,1	42	1.1	130.14
745-32-0079-111	80	78,8 - 83,0	79,9	42	2.2	260.81
745-32-0084-111	80	82,5 - 86,0	84,0	42	2.3	264.74
745-32-0089-111	80	88,0 - 92,0	88,9	42	2.3	268.71
745-32-0101-111	100	100,0 - 104,0	101,6	42	2.4	271.69
745-32-0104-111	100	102,0 - 106,0	104,0	42	2.4	282.61
745-32-0106-111	100	105,0 - 108,0	106,3	42	2.4	286.86
745-32-0108-111	100	106,0 - 110,0	108,0	42	2.4	291.16
745-32-0114-111	100	113,0 - 118,0	114,3	42	2.5	295.53
745-32-0127-111	125	125,0 - 129,0	127,0	42	3.3	401.20
745-32-0129-111	125	127,5 - 131,0	129,0	42	3.3	407.23
745-32-0133-111	125	131,0 - 135,0	131,7	42	3.3	413.35
745-32-0139-111	125	138,0 - 142,0	139,7	42	3.4	419.50
745-32-0141-111	125	139,5 - 144,0	141,3	42	3.4	425.81
745-32-0154-111	150	151,5 - 156,0	154,0	42	3.6	453.38
745-32-0159-111	150	156,0 - 161,0	157,7	42	3.6	460.19
745-32-0165-111	150	164,0 - 168,0	165,2	42	3.7	467.08
745-32-0168-111	150	166,0 - 170,0	168,3	42	3.7	474.07
745-32-0180-111	175	178,0 - 183,0	180,0	42	3.8	817.22
745-32-0200-111	200	198,0 - 203,0	200,0	32	7.2	829.51
745-32-0204-111	200	202,0 - 206,0	204,0	32	7.3	841.90
745-32-0216-111	200	214,0 - 219,0	216,3	32	7.5	854.56
745-32-0219-111	200	216,5 - 222,0	219,1	32	7.5	867.36
745-32-0254-111	225	251,0 - 257,0	254,0	26	8.0	879.12
745-32-0267-111	250	262,0 - 270,0	267,4	26	8.3	892.29
745-32-0273-111	250	270,0 - 277,0	273,0	26	8.3	905.67
745-32-0304-111	300	301,5 - 309,0	304,0	26	8.8	944.11
745-32-0318-111	300	316,0 - 323,0	318,5	26	9.0	958.24
745-32-0323-111	300	322,0 - 329,0	323,9	26	9.1	972.63
745-32-0355-111	350	352,0 - 361,0	355,6	26	9.6	1,058.83
745-32-0406-111	400	402,0 - 411,0	406,4	26	10	1,137.38
745-32-0457-111	450	453,0 - 462,0	457,2	25	11	1,209.61
745-32-0508-111	500	504,0 - 513,0	508,0	18	12	1,278.78
745-32-0558-111	550	555,0 - 564,0	558,8	18	13	1,344.72
745-32-0609-111	600	605,0 - 615,0	609,6	16	13	1,410.65
745-32-0660-111	650	654,0 - 666,0	660,4	16	14	1,486.11
745-32-0711-111	700	705,0 - 717,0	711,2	14	15	1,552.14
745-32-0762-111	750	756,0 - 768,0	762,0	14	16	1,621.21
745-32-0812-111	800	806,0 - 818,0	812,8	13	17	1,696.66
745-32-0863-111	850	857,0 - 869,0	863,6	12	17	1,775.16
745-32-0914-111	900	906,0 - 920,0	914,4	11	18	1,856.84
745-32-1016-111	1000	1010,0 - 1022,0	1016,0	10	20	2,045.36

745/32-112

Repico® SDF
 Slip type coupling with two
 locks
 Flexible / non-tensile restraint
 For all pipe types
 Stainless steel
 NBR rubber



AVK ref. no.	DN mm	Tolerance mm	Pipe dia. mm	Working Pressure bar	Theoretical weight/kg	Gross Price EUR
745-32-0076-112	65	75,0 - 79,0	76,1	42	1.1	130.14
745-32-0079-112	80	78,8 - 83,0	79,9	42	2.2	260.81
745-32-0084-112	80	82,5 - 86,0	84,0	42	2.3	264.74
745-32-0089-112	80	88,0 - 92,0	88,9	42	2.3	268.71
745-32-0101-112	100	100,0 - 104,0	101,6	42	2.4	271.69
745-32-0104-112	100	102,0 - 106,0	104,0	42	2.4	282.61
745-32-0106-112	100	105,0 - 108,0	106,3	42	2.4	286.86
745-32-0108-112	100	106,0 - 110,0	108,0	42	2.4	291.16
745-32-0114-112	100	113,0 - 118,0	114,3	42	2.5	295.53
745-32-0127-112	125	125,0 - 129,0	127,0	42	3.3	401.20
745-32-0129-112	125	127,5 - 131,0	129,0	42	3.3	407.23
745-32-0133-112	125	131,0 - 135,0	131,7	42	3.3	413.35
745-32-0139-112	125	138,0 - 142,0	139,7	42	3.4	419.50
745-32-0141-112	125	139,5 - 144,0	141,3	42	3.4	425.81
745-32-0154-112	150	151,5 - 156,0	154,0	42	3.6	453.38
745-32-0159-112	150	156,0 - 161,0	157,7	42	3.6	460.19
745-32-0165-112	150	164,0 - 168,0	165,2	42	3.7	467.08
745-32-0168-112	150	166,0 - 170,0	168,3	42	3.7	474.07
745-32-0180-112	175	178,0 - 183,0	180,0	42	3.8	817.22
745-32-0200-112	200	198,0 - 203,0	200,0	32	7.2	829.51
745-32-0204-112	200	202,0 - 206,0	204,0	32	7.3	841.90
745-32-0216-112	200	214,0 - 219,0	216,3	32	7.5	854.56
745-32-0219-112	200	216,5 - 222,0	219,1	32	7.5	867.36
745-32-0254-112	225	251,0 - 257,0	254,0	26	8.0	879.12
745-32-0267-112	250	262,0 - 270,0	267,4	26	8.3	892.29
745-32-0273-112	250	270,0 - 277,0	273,0	26	8.3	905.67
745-32-0304-112	300	301,5 - 309,0	304,0	26	8.8	944.11
745-32-0318-112	300	316,0 - 323,0	318,5	26	9.0	958.24
745-32-0323-112	300	322,0 - 329,0	323,9	26	9.1	972.63
745-32-0355-112	350	352,0 - 361,0	355,6	26	9.6	1,058.83
745-32-0406-112	400	402,0 - 411,0	406,4	26	10	1,137.38
745-32-0457-112	450	453,0 - 462,0	457,2	25	11	1,209.61
745-32-0508-112	500	504,0 - 513,0	508,0	18	12	1,278.78
745-32-0558-112	550	555,0 - 564,0	558,8	18	13	1,344.72
745-32-0609-112	600	605,0 - 615,0	609,6	16	13	1,410.65
745-32-0660-112	650	654,0 - 666,0	660,4	16	14	1,486.11
745-32-0711-112	700	705,0 - 717,0	711,2	14	15	1,552.14
745-32-0762-112	750	756,0 - 768,0	762,0	14	16	1,621.21
745-32-0812-112	800	806,0 - 818,0	812,8	13	17	1,696.66
745-32-0863-112	850	857,0 - 869,0	863,6	12	17	1,775.16
745-32-0914-112	900	906,0 - 920,0	914,4	11	18	1,856.84
745-32-1016-112	1000	1010,0 - 1022,0	1016,0	10	20	2,045.36

745/33-111

AVK Repico® SDFL
Slip type coupling with two
locks high pressure - long
version
Flexible / non-tensile restraint
For all pipes
Stainless steel
EPDM drinking water
approved



Note: Repico® Slip couplings
are also available in three or
four locks.
Please contact our sales
department for more
information.
Tel. +31 (0)578 560 602

AVK ref. no.	DN mm	Tolerance mm	Pipe dia. mm	Working Pressure bar	Theoretical weight/kg	Gross Price EUR
745-33-0089-111	80	88,0 - 92,0	88,9	42	4.0	413.01
745-33-0101-111	100	100,0 - 104,0	101,6	42	4.2	426.57
745-33-0104-111	100	102,0 - 106,0	104,0	42	4.2	442.91
745-33-0106-111	100	105,0 - 108,0	106,3	42	4.2	449.52
745-33-0108-111	100	106,0 - 110,0	108,0	42	4.2	456.27
745-33-0114-111	100	113,0 - 118,0	114,3	42	4.3	463.16
745-33-0139-111	125	138,0 - 142,0	139,7	42	6.0	680.26
745-33-0141-111	125	139,5 - 144,0	141,3	42	6.0	690.49
745-33-0159-111	150	156,0 - 161,0	157,7	42	6.3	735.27
745-33-0165-111	150	164,0 - 168,0	165,2	42	6.5	746.33
745-33-0168-111	150	166,0 - 170,0	168,3	42	6.5	757.51
745-33-0216-111	200	214,0 - 219,0	216,3	32	16	1,486.11
745-33-0219-111	200	216,5 - 222,0	219,1	32	16	1,508.42
745-33-0267-111	250	262,0 - 270,0	267,4	26	17	1,574.10
745-33-0273-111	250	270,0 - 277,0	273,0	26	17	1,597.69
745-33-0318-111	300	316,0 - 323,0	318,5	26	18	1,658.89
745-33-0323-111	300	322,0 - 329,0	323,9	26	18	1,683.83
745-33-0355-111	350	352,0 - 361,0	355,6	26	19	1,885.12
745-33-0406-111	400	402,0 - 411,0	406,4	26	20	2,004.54
745-33-0457-111	450	453,0 - 462,0	457,2	25	22	2,114.44
745-33-0508-111	500	504,0 - 513,0	508,0	18	23	2,205.58
745-33-0558-111	550	555,0 - 564,0	558,8	18	24	2,340.69
745-33-0609-111	600	605,0 - 615,0	609,6	16	26	2,450.64
745-33-0660-111	650	654,0 - 666,0	660,4	16	27	2,579.52
745-33-0711-111	700	705,0 - 717,0	711,2	14	28	2,698.89
745-33-0762-111	750	756,0 - 768,0	762,0	14	29	2,827.75
745-33-0812-111	800	806,0 - 818,0	812,8	13	31	2,950.24
745-33-0863-111	850	857,0 - 869,0	863,6	12	32	3,072.75
745-33-0914-111	900	906,0 - 920,0	914,4	11	33	3,185.87
745-33-1016-111	1000	1010,0 - 1022,0	1016,0	10	36	3,427.81

745/33-112

AVK Repico® SDFL
Slip type coupling with two
locks high pressure - long
version
Flexible / non-tensile restraint
For all pipes
Stainless steel
NBR rubber



Note: Repico® Slip couplings
are also available in three or
four locks.
Please contact our sales
department for more
information.
Tel. +31 (0)578 560 602

AVK ref. no.	DN mm	Tolerance mm	Pipe dia. mm	Working Pressure bar	Theoretical weight/kg	Gross Price EUR
745-33-0089-112	80	88,0 - 92,0	88,9	42	4.0	413.01
745-33-0101-112	100	100,0 - 104,0	101,6	42	4.2	426.57
745-33-0104-112	100	102,0 - 106,0	104,0	42	4.2	442.91
745-33-0106-112	100	105,0 - 108,0	106,3	42	4.2	449.52
745-33-0108-112	100	106,0 - 110,0	108,0	42	4.2	456.27
745-33-0114-112	100	113,0 - 118,0	114,3	42	4.3	463.16
745-33-0139-112	125	138,0 - 142,0	139,7	42	6.0	680.26
745-33-0141-112	125	139,5 - 144,0	141,3	42	6.0	690.49
745-33-0159-112	150	156,0 - 161,0	157,7	42	6.3	735.27
745-33-0165-112	150	164,0 - 168,0	165,2	42	6.5	746.33
745-33-0168-112	150	166,0 - 170,0	168,3	42	6.5	757.51
745-33-0216-112	200	214,0 - 219,0	216,3	32	16	1,486.11
745-33-0219-112	200	216,5 - 222,0	219,1	32	16	1,508.42
745-33-0267-112	250	262,0 - 270,0	267,4	26	17	1,574.10
745-33-0273-112	250	270,0 - 277,0	273,0	26	17	1,597.69
745-33-0318-112	300	316,0 - 323,0	318,5	26	18	1,658.89
745-33-0323-112	300	322,0 - 329,0	323,9	26	18	1,683.83
745-33-0355-112	350	352,0 - 361,0	355,6	26	19	1,885.12
745-33-0406-112	400	402,0 - 411,0	406,4	26	20	2,004.54
745-33-0457-112	450	453,0 - 462,0	457,2	25	22	2,114.44
745-33-0508-112	500	504,0 - 513,0	508,0	18	23	2,205.58
745-33-0558-112	550	555,0 - 564,0	558,8	18	24	2,340.69
745-33-0609-112	600	605,0 - 615,0	609,6	16	26	2,450.64
745-33-0660-112	650	654,0 - 666,0	660,4	16	27	2,579.52
745-33-0711-112	700	705,0 - 717,0	711,2	14	28	2,698.89
745-33-0762-112	750	756,0 - 768,0	762,0	14	29	2,827.75
745-33-0812-112	800	806,0 - 818,0	812,8	13	31	2,950.24
745-33-0863-112	850	857,0 - 869,0	863,6	12	32	3,072.75
745-33-0914-112	900	906,0 - 920,0	914,4	11	33	3,185.87
745-33-1016-112	1000	1010,0 - 1022,0	1016,0	10	36	3,427.81

745/52-111

Repico® SG
 Slip Grip type coupling
 Tensile / axial restraint - non-
 tensile
 For metal pipes
 Stainless steel
 EPDM drinking water
 approved



AVK ref. no.	DN mm	Tolerance mm	Pipe dia. mm	Working Pressure bar	Theoretical weight/kg	Gross Price EUR
745-52-0020-11107	15	19,5 - 20,5	20,0	42,7	0,2	71.34
745-52-0021-11107	15	21,2 - 22,2	21,3	42,7	0,2	72.44
745-52-0025-11107	20	24,5 - 25,5	25,0	42,7	0,3	87.16
745-52-0027-11107	20	26,7 - 27,7	26,7	42,7	0,3	88.50
745-52-0028-11107	25	27,5 - 29,0	28,2	42,7	0,3	91.13
745-52-0030-11107	25	29,5 - 30,5	30,0	42,7	0,3	92.50
745-52-0032-11107	25	31,5 - 32,5	32,0	42,7	0,3	93.90
745-52-0034-11107	25	33,0 - 34,6	33,4	42,7	0,3	95.31
745-52-0038-11107	32	37,5 - 38,5	38,0	42,7	0,4	97.05
745-52-0040-11107	32	39,5 - 41,5	40,0	42,7	0,4	98.01
745-52-0042-11107	32	41,9 - 43,0	42,2	42,7	0,4	99.06
745-52-0044-11107	32	44,0 - 45,0	44,5	42,7	0,4	100.01
745-52-0048-11107	40	47,8 - 49,0	48,3	42,7	0,4	101.03
745-52-0050-11107	50	49,5 - 51,5	50,8	42,7	0,4	106.25
745-52-0054-11107	50	53,4 - 54,6	54,0	42,7	0,6	107.85
745-52-0057-11107	50	56,4 - 57,6	57,0	42,7	0,6	109.46
745-52-0060-11107	50	59,0 - 61,5	60,3	42,7	0,7	111.06
745-52-0063-11107	50	62,4 - 63,6	63,0	42,7	0,7	112.74
745-52-0066-11107	65	65,2 - 67,3	66,7	37,3	0,7	129.00
745-52-0069-11107	65	68,0 - 70,1	69,0	37,3	0,7	130.98
745-52-0073-11107	65	71,5 - 74,1	73,0	37,3	0,7	132.91
745-52-0076-11107	65	75,0 - 77,2	76,1	37,3	0,7	134.91
745-52-0079-11107	80	78,8 - 80,8	79,9	37,3	1,3	150.92
745-52-0084-11107	80	83,0 - 84,9	84,0	37,3	1,4	153.23
745-52-0089-11107	80	87,8 - 91,0	88,9	37,3	1,4	155.47
745-52-0101-11107	100	100,4 - 102,0	101,6	37,3	1,5	156.18
745-52-0104-11107	100	103,0 - 104,0	104,0	37,3	1,5	166.53
745-52-0106-11107	100	105,0 - 107,0	106,3	37,3	1,5	169.03
745-52-0108-11107	100	106,5 - 108,0	108,0	37,3	1,5	171.54
745-52-0114-11107	100	113,2 - 115,0	114,3	37,3	1,6	174.17
745-52-0127-11107	125	125,6 - 128,0	127,0	37,3	1,9	252.32
745-52-0129-11107	125	127,5 - 130,0	129,0	37,3	2,0	256.13
745-52-0133-11107	125	131,6 - 134,0	131,7	37,3	2,0	259.99
745-52-0139-11107	125	137,7 - 140,0	139,7	37,3	2,0	263.84
745-52-0141-11107	125	139,7 - 142,0	141,3	37,3	2,0	267.83
745-52-0154-11107	150	151,5 - 155,0	154,0	32	2,1	295.14
745-52-0159-11107	150	156,5 - 160,0	157,7	32	2,2	299.57
745-52-0165-11107	150	163,3 - 166,0	165,2	32	2,2	304.07
745-52-0168-11107	150	166,6 - 170,0	168,3	32	2,3	308.64
745-52-0180-11107	175	178,0 - 182,0	180,0	26,7	2,4	472.41
745-52-0216-11107	200	214,5 - 218,0	216,3	21,3	4,6	493.99
745-52-0219-11107	200	217,0 - 221,0	219,1	21,3	4,7	501.41
745-52-0267-11107	250	264,8 - 270,0	267,4	21,3	5,2	604.41
745-52-0273-11107	250	270,4 - 275,0	273,0	21,3	5,3	613.53
745-52-0318-11107	300	316,0 - 322,0	318,5	18,7	5,9	651.01

745/52-112

Repico® SG
 Slip Grip type coupling
 Tensile / axial restraint - non-
 tensile
 For metal pipes
 Stainless steel
 NBR rubber



AVK ref. no.	DN mm	Tolerance mm	Pipe dia. mm	Working Pressure bar	Theoretical weight/kg	Gross Price EUR
745-52-0020-11207	15	19,5 - 20,5	20,0	42,7	0,2	71.34
745-52-0021-11207	15	21,2 - 22,2	21,3	42,7	0,2	72.44
745-52-0025-11207	20	24,5 - 25,5	25,0	42,7	0,3	87.16
745-52-0027-11207	20	26,7 - 27,7	26,7	42,7	0,3	88.50
745-52-0028-11207	25	27,5 - 29,0	28,2	42,7	0,3	91.13
745-52-0030-11207	25	29,5 - 30,5	30,0	42,7	0,3	92.50
745-52-0032-11207	25	31,5 - 32,5	32,0	42,7	0,3	93.90
745-52-0034-11207	25	33,0 - 34,6	33,4	42,7	0,3	95.31
745-52-0038-11207	32	37,5 - 38,5	38,0	42,7	0,4	97.05
745-52-0040-11207	32	39,5 - 41,5	40,0	42,7	0,4	98.01
745-52-0042-11207	32	41,9 - 43,0	42,2	42,7	0,4	99.06
745-52-0044-11207	32	44,0 - 45,0	44,5	42,7	0,4	100.01
745-52-0048-11207	40	47,8 - 49,0	48,3	42,7	0,4	101.03
745-52-0050-11207	50	49,5 - 51,5	50,8	42,7	0,4	106.25
745-52-0054-11207	50	53,4 - 54,6	54,0	42,7	0,6	107.85
745-52-0057-11207	50	56,4 - 57,6	57,0	42,7	0,6	109.46
745-52-0060-11207	50	59,0 - 61,5	60,3	42,7	0,7	111.06
745-52-0063-11207	50	62,4 - 63,6	63,0	42,7	0,7	112.74
745-52-0066-11207	65	65,2 - 67,3	66,7	37,3	0,7	129.00
745-52-0069-11207	65	68,0 - 70,1	69,0	37,3	0,7	130.98
745-52-0073-11207	65	71,5 - 74,1	73,0	37,3	0,7	132.91
745-52-0076-11207	65	75,0 - 77,2	76,1	37,3	0,7	134.91
745-52-0079-11207	80	78,8 - 80,8	79,9	37,3	1,3	150.92
745-52-0084-11207	80	83,0 - 84,9	84,0	37,3	1,4	153.23
745-52-0089-11207	80	87,8 - 91,0	88,9	37,3	1,4	155.47
745-52-0101-11207	100	100,4 - 102,0	101,6	37,3	1,5	156.18
745-52-0104-11207	100	103,0 - 104,0	104,0	37,3	1,5	166.53
745-52-0106-11207	100	105,0 - 107,0	106,3	37,3	1,5	169.03
745-52-0108-11207	100	106,5 - 108,0	108,0	37,3	1,5	171.54
745-52-0114-11207	100	113,2 - 115,0	114,3	37,3	1,6	174.17
745-52-0127-11207	125	125,6 - 128,0	127,0	37,3	1,9	252.32
745-52-0129-11207	125	127,5 - 130,0	129,0	37,3	2,0	256.13
745-52-0133-11207	125	131,6 - 134,0	131,7	37,3	2,0	259.99
745-52-0139-11207	125	137,7 - 140,0	139,7	37,3	2,0	263.84
745-52-0141-11207	125	139,7 - 142,0	141,3	37,3	2,0	267.83
745-52-0154-11207	150	151,5 - 155,0	154,0	32	2,1	295.14
745-52-0159-11207	150	156,5 - 160,0	157,7	32	2,2	299.57
745-52-0165-11207	150	163,3 - 166,0	165,2	32	2,2	304.07
745-52-0168-11207	150	166,6 - 170,0	168,3	32	2,3	308.64
745-52-0180-11207	175	178,0 - 182,0	180,0	26,7	2,4	472.41
745-52-0216-11207	200	214,5 - 218,0	216,3	21,3	4,6	493.99
745-52-0219-11207	200	217,0 - 221,0	219,1	21,3	4,7	501.41
745-52-0267-11207	250	264,8 - 270,0	267,4	21,3	5,2	604.41
745-52-0273-11207	250	270,4 - 275,0	273,0	21,3	5,3	613.53
745-52-0318-11207	300	316,0 - 322,0	318,5	18,7	5,9	651.01
745-52-0323-11207	300	321,0 - 327,0	323,9	18,7	5,9	660.79

745/52-113

Repico® SG
 Slip Grip type coupling
 Tensile / axial restraint - non-
 tensile
 For metal pipes
 Stainless steel
 Silicone rubber



AVK ref. no.	DN mm	Tolerance mm	Pipe dia. mm	Working Pressure bar	Theoretical weight/kg	Gross Price EUR
745-52-0020-11307	15	19,5 - 20,5	20,0	42	0.2	83.23
745-52-0021-11307	15	21,2 - 22,2	21,3	42	0.2	84.45
745-52-0025-11307	20	24,5 - 25,5	25,0	42	0.3	99.11
745-52-0027-11307	20	26,7 - 27,7	26,7	42	0.3	100.59
745-52-0028-11307	25	27,5 - 29,0	28,2	42	0.3	107.00
745-52-0030-11307	25	29,5 - 30,5	30,0	42	0.3	108.62
745-52-0032-11307	25	31,5 - 32,5	32,0	42	0.3	110.28
745-52-0034-11307	25	33,0 - 34,6	33,4	42	0.3	110.80
745-52-0038-11307	32	37,5 - 38,5	38,0	42	0.4	110.94
745-52-0040-11307	32	39,5 - 41,5	40,0	42	0.4	112.03
745-52-0042-11307	32	41,9 - 43,0	42,2	42	0.4	113.19
745-52-0044-11307	32	44,0 - 45,0	44,5	42	0.4	114.28
745-52-0048-11307	40	47,8 - 49,0	48,3	42	0.4	118.91
745-52-0050-11307	50	49,5 - 51,5	50,8	42	0.4	133.18
745-52-0054-11307	50	53,4 - 54,6	54,0	42	0.6	135.17
745-52-0057-11307	50	56,4 - 57,6	57,0	42	0.6	137.22
745-52-0060-11307	50	59,0 - 61,5	60,3	42	0.7	139.28
745-52-0063-11307	50	62,4 - 63,6	63,0	42	0.7	141.33
745-52-0066-11307	65	65,2 - 67,3	66,7	37	0.7	170.90
745-52-0069-11307	65	68,0 - 70,1	69,0	37	0.7	173.47
745-52-0073-11307	65	71,5 - 74,1	73,0	37	0.7	176.12
745-52-0076-11307	65	75,0 - 77,2	76,1	37	0.7	178.74
745-52-0079-11307	80	78,8 - 80,8	79,9	37	1.3	192.56
745-52-0084-11307	80	83,0 - 84,9	84,0	37	1.4	195.45
745-52-0089-11307	80	87,8 - 91,0	88,9	37	1.4	198.34
745-52-0101-11307	100	100,4 - 102,0	101,6	37	1.5	199.06
745-52-0104-11307	100	103,0 - 104,0	104,0	37	1.5	205.54
745-52-0106-11307	100	105,0 - 107,0	106,3	37	1.5	208.63
745-52-0108-11307	100	106,5 - 108,0	108,0	37	1.5	211.78
745-52-0114-11307	100	113,2 - 115,0	114,3	37	1.6	214.92
745-52-0127-11307	125	125,6 - 128,0	127,0	37	1.9	329.72
745-52-0129-11307	125	127,5 - 130,0	129,0	37	2.0	334.66
745-52-0133-11307	125	131,6 - 134,0	131,7	37	2.0	339.67
745-52-0139-11307	125	137,7 - 140,0	139,7	37	2.0	344.75
745-52-0141-11307	125	139,7 - 142,0	141,3	37	2.0	349.90
745-52-0154-11307	150	151,5 - 155,0	154,0	32	2.1	375.55
745-52-0159-11307	150	156,5 - 160,0	157,7	32	2.2	381.20
745-52-0165-11307	150	163,3 - 166,0	165,2	32	2.2	386.93
745-52-0168-11307	150	166,6 - 170,0	168,3	32	2.3	392.71
745-52-0180-11307	175	178,0 - 182,0	180,0	26	2.4	657.25
745-52-0200-11307	200	198,2 - 201,0	200,0	21	4.4	657.25
745-52-0204-11307	200	202,7 - 206,0	204,0	21	4.5	667.08
745-52-0216-11307	200	214,5 - 218,0	216,3	21	4.6	677.12
745-52-0219-11307	200	217,0 - 221,0	219,1	21	4.7	687.27
745-52-0254-11307	225	251,4 - 256,0	254,0	21	5.1	833.10
745-52-0267-11307	250	264,8 - 270,0	267,4	21	5.2	833.10
745-52-0273-11307	250	270,4 - 275,0	273,0	21	5.3	845.65
745-52-0304-11307	300	301,5 - 306,0	304,0	18	5.7	899.04
745-52-0318-11307	300	316,0 - 322,0	318,5	18	5.9	899.04
745-52-0323-11307	300	321,0 - 327,0	323,9	18	5.9	912.48

747/01-111

Repico® RSD
 Repair coupling with two
 locks
 For all pipe types
 Stainless steel
 EPDM drinking water
 approved



AVK ref. no.	DN mm	Tolerance mm	Pipe dia. mm	Working Pressure bar	Theoretical weight/kg	Gross Price EUR
747-01-0015-111	15	15,3 - 17,0	15,5	42,7	0,3	213.20
747-01-0020-111	15	19,5 - 21,3	20,0	42,7	0,3	214.23
747-01-0021-111	15	21,0 - 23,0	21,3	42,7	0,3	215.31
747-01-0025-111	20	24,0 - 26,5	25,0	42,7	0,5	216.41
747-01-0027-111	20	26,0 - 28,5	26,7	42,7	0,5	217.43
747-01-0028-111	25	26,4 - 29,5	28,2	42,7	0,5	219.62
747-01-0030-111	25	29,0 - 31,5	30,0	42,7	0,5	220.52
747-01-0032-111	25	31,0 - 33,5	32,0	42,7	0,5	221.41
747-01-0034-111	25	33,0 - 35,5	33,4	42,7	0,5	222.25
747-01-0038-111	32	37,0 - 39,5	38,0	42,7	0,6	222.82
747-01-0040-111	32	39,5 - 41,8	40,0	42,7	0,6	223.92
747-01-0042-111	32	42,0 - 44,5	42,2	42,7	0,6	225.03
747-01-0044-111	32	44,0 - 46,5	44,5	42,7	0,6	226.19
747-01-0048-111	40	47,5 - 50,5	48,3	42,7	0,6	229.59
747-01-0050-111	50	49,2 - 51,5	50,8	42,7	0,6	291.27
747-01-0054-111	50	53,0 - 56,0	54,0	42,7	0,9	292.77
747-01-0057-111	50	56,0 - 59,0	57,0	42,7	0,9	294.24
747-01-0060-111	50	59,0 - 62,0	60,3	42,7	0,9	295.71
747-01-0063-111	50	62,0 - 65,0	63,0	42,7	0,9	297.20
747-01-0066-111	65	65,4 - 69,0	66,7	37	0,9	308.90
747-01-0069-111	65	68,5 - 72,0	69,0	37	1,0	311.98
747-01-0073-111	65	72,5 - 76,5	73,0	37	1,0	315.14
747-01-0076-111	65	75,0 - 79,0	76,1	37	1,0	318.26
747-01-0079-111	80	78,8 - 83,0	79,9	37	2,0	369.63
747-01-0084-111	80	82,5 - 86,0	84,0	37	2,0	373.35
747-01-0089-111	80	88,0 - 92,0	88,9	37	2,0	377.11
747-01-0101-111	100	100,0 - 104,0	101,6	37	2,1	380.87
747-01-0104-111	100	102,0 - 106,0	104,0	37	2,1	382.72
747-01-0106-111	100	105,0 - 108,0	106,3	37	2,1	388.49
747-01-0108-111	100	106,0 - 110,0	108,0	37	2,1	394.34
747-01-0114-111	100	113,0 - 118,0	114,3	37	2,2	400.23
747-01-0127-111	125	125,0 - 129,0	127,0	37	2,6	461.66
747-01-0129-111	125	127,5 - 131,0	129,0	37	2,6	468.60
747-01-0133-111	125	131,0 - 135,0	131,7	37	2,6	475.64
747-01-0139-111	125	138,0 - 142,0	139,7	37	2,7	482.82
747-01-0141-111	125	139,5 - 144,0	141,3	37	2,7	490.05
747-01-0154-111	150	151,5 - 156,0	154,0	32	2,8	497.38
747-01-0159-111	150	156,0 - 161,0	157,7	32	2,8	504.84
747-01-0165-111	150	164,0 - 168,0	165,2	32	2,9	512.38
747-01-0168-111	150	166,0 - 170,0	168,3	32	2,9	520.04
747-01-0180-111	175	178,0 - 183,0	180,0	26	3,0	527.90
747-01-0200-111	200	198,0 - 203,0	200,0	21	5,9	764.20
747-01-0204-111	200	202,0 - 206,0	204,0	21	5,9	768.06
747-01-0216-111	200	214,0 - 219,0	216,3	21	6,1	771.87
747-01-0219-111	200	216,5 - 222,0	219,1	21	6,1	775.78
747-01-0254-111	225	251,0 - 257,0	254,0	21	6,5	1,024.45
747-01-0267-111	250	262,0 - 270,0	267,4	21	6,6	1,029.52
747-01-0273-111	250	270,0 - 277,0	273,0	21	6,7	1,034.66
747-01-0304-111	275	301,5 - 309,0	304,0	18	7,0	1,095.73
747-01-0318-111	300	316,0 - 323,0	318,5	18	7,2	1,112.11
747-01-0323-111	300	322,0 - 329,0	323,9	18	7,3	1,128.83
747-01-0355-111	350	352,0 - 361,0	355,6	18	7,6	1,215.92
747-01-0406-111	400	402,0 - 411,0	406,4	16	8,3	1,234.17
747-01-0457-111	450	453,0 - 462,0	457,2	16	8,9	1,367.39
747-01-0508-111	500	504,0 - 513,0	508,0	13	9,4	1,447.62
747-01-0558-111	550	555,0 - 564,0	558,8	12	10	1,518.90
747-01-0609-111	600	605,0 - 615,0	609,6	11	11	1,590.04
747-01-0660-111	650	654,0 - 666,0	660,4	10	11	1,670.26
747-01-0711-111	700	705,0 - 717,0	711,2	9	12	1,745.96
747-01-0762-111	750	756,0 - 768,0	762,0	9	12	1,772.19
747-01-0812-111	800	806,0 - 818,0	812,8	9	13	1,901.83
747-01-0863-111	850	857,0 - 869,0	863,6	8	13	1,930.38
747-01-0914-111	900	906,0 - 920,0	914,4	8	14	1,959.29
747-01-1016-111	1000	1010,0 - 1022,0	1016,0	7	15	2,284.91

747/01-112

Repico® RSD
 Repair coupling with two
 locks
 For all pipe types
 Stainless steel
 NBR rubber



AVK ref. no.	DN mm	Tolerance mm	Pipe dia. mm	Working Pressure bar	Theoretical weight/kg	Gross Price EUR
747-01-0015-112	15	15,3 - 17,0	15,5	42	0.3	213.20
747-01-0020-112	15	19,5 - 21,3	20,0	42	0.3	214.23
747-01-0021-112	15	21,0 - 23,0	21,3	42	0.3	215.31
747-01-0025-112	20	24,0 - 26,5	25,0	42	0.5	216.41
747-01-0027-112	20	26,0 - 28,5	26,7	42	0.5	217.43
747-01-0028-112	25	26,4 - 29,5	28,2	42	0.5	219.62
747-01-0030-112	25	29,0 - 31,5	30,0	42	0.5	220.52
747-01-0032-112	25	31,0 - 33,5	32,0	42	0.5	221.41
747-01-0034-112	25	33,0 - 35,5	33,4	42	0.5	222.25
747-01-0038-112	32	37,0 - 39,5	38,0	42	0.6	222.82
747-01-0040-112	32	39,5 - 41,8	40,0	42	0.6	223.92
747-01-0042-112	32	42,0 - 44,5	42,2	42	0.6	225.03
747-01-0044-112	32	44,0 - 46,5	44,5	42	0.6	226.19
747-01-0048-112	40	47,5 - 50,5	48,3	42	0.6	229.59
747-01-0050-112	50	49,2 - 51,5	50,8	42	0.6	291.27
747-01-0054-112	50	53,0 - 56,0	54,0	42	0.9	292.77
747-01-0057-112	50	56,0 - 59,0	57,0	42	0.9	294.24
747-01-0060-112	50	59,0 - 62,0	60,3	42	0.9	295.71
747-01-0063-112	50	62,0 - 65,0	63,0	42	0.9	297.20
747-01-0066-112	65	65,4 - 69,0	66,7	37	0.9	308.90
747-01-0069-112	65	68,5 - 72,0	69,0	37	1.0	311.98
747-01-0073-112	65	72,5 - 76,5	73,0	37	1.0	315.14
747-01-0076-112	65	75,0 - 79,0	76,1	37	1.0	318.26
747-01-0079-112	80	78,8 - 83,0	79,9	37	2.0	369.63
747-01-0084-112	80	82,5 - 86,0	84,0	37	2.0	373.35
747-01-0089-112	80	88,0 - 92,0	88,9	37	2.0	377.11
747-01-0101-112	100	100,0 - 104,0	101,6	37	2.1	380.87
747-01-0104-112	100	102,0 - 106,0	104,0	37	2.1	382.72
747-01-0106-112	100	105,0 - 108,0	106,3	37	2.1	388.49
747-01-0108-112	100	106,0 - 110,0	108,0	37	2.1	394.34
747-01-0114-112	100	113,0 - 118,0	114,3	37	2.2	400.23
747-01-0127-112	125	125,0 - 129,0	127,0	37	2.6	461.66
747-01-0129-112	125	127,5 - 131,0	129,0	37	2.6	468.60
747-01-0133-112	125	131,0 - 135,0	131,7	37	2.6	475.64
747-01-0139-112	125	138,0 - 142,0	139,7	37	2.7	482.82
747-01-0141-112	125	139,5 - 144,0	141,3	37	2.7	490.05
747-01-0154-112	150	151,5 - 156,0	154,0	32	2.8	497.38
747-01-0159-112	150	156,0 - 161,0	157,7	32	2.8	504.84
747-01-0165-112	150	164,0 - 168,0	165,2	32	2.9	512.38
747-01-0168-112	150	166,0 - 170,0	168,3	32	2.9	520.04
747-01-0180-112	175	178,0 - 183,0	180,0	26	3.0	527.90
747-01-0200-112	200	198,0 - 203,0	200,0	21	5.9	764.20
747-01-0204-112	200	202,0 - 206,0	204,0	21	5.9	768.06
747-01-0216-112	200	214,0 - 219,0	216,3	21	6.1	771.87
747-01-0219-112	200	216,5 - 222,0	219,1	21	6.1	775.78
747-01-0254-112	225	251,0 - 257,0	254,0	21	6.5	1,024.45
747-01-0267-112	250	262,0 - 270,0	267,4	21	6.6	1,029.52
747-01-0273-112	250	270,0 - 277,0	273,0	21	6.7	1,034.66
747-01-0304-112	275	301,5 - 309,0	304,0	18	7.0	1,095.73
747-01-0318-112	300	316,0 - 323,0	318,5	18	7.2	1,112.11
747-01-0323-112	300	322,0 - 329,0	323,9	18	7.3	1,128.83
747-01-0355-112	350	352,0 - 361,0	355,6	18	7.6	1,215.92
747-01-0406-112	400	402,0 - 411,0	406,4	16	8.3	1,234.17
747-01-0457-112	450	453,0 - 462,0	457,2	16	8.9	1,367.39
747-01-0508-112	500	504,0 - 513,0	508,0	13	9.4	1,447.62
747-01-0558-112	550	555,0 - 564,0	558,8	12	10	1,518.90
747-01-0609-112	600	605,0 - 615,0	609,6	11	11	1,590.04
747-01-0660-112	650	654,0 - 666,0	660,4	10	11	1,670.26
747-01-0711-112	700	705,0 - 717,0	711,2	9	12	1,745.96
747-01-0762-112	750	756,0 - 768,0	762,0	9	12	1,772.19
747-01-0812-112	800	806,0 - 818,0	812,8	9	13	1,901.83
747-01-0863-112	850	857,0 - 869,0	863,6	8	13	1,930.38
747-01-0914-112	900	906,0 - 920,0	914,4	8	14	1,959.29
747-01-1016-112	1000	1010,0 - 1022,0	1016,0	7	15	2,284.91

747/01-113

Repico® RSD
 Repair coupling with two
 locks
 For all pipe types
 Stainless steel
 Silicone rubber



AVK ref. no.	DN mm	Tolerance mm	Pipe dia. mm	Working Pressure bar	Theoretical weight/kg	Gross Price EUR
747-01-0015-113	15	15,3 - 17,0	15,5	42	0.3	225.98
747-01-0020-113	15	19,5 - 21,3	20,0	42	0.3	227.13
747-01-0021-113	15	21,0 - 23,0	21,3	42	0.3	228.24
747-01-0025-113	20	24,0 - 26,5	25,0	42	0.5	229.38
747-01-0027-113	20	26,0 - 28,5	26,7	42	0.5	230.54
747-01-0028-113	25	26,4 - 29,5	28,2	42	0.5	238.97
747-01-0030-113	25	29,0 - 31,5	30,0	42	0.5	239.86
747-01-0032-113	25	31,0 - 33,5	32,0	42	0.5	240.82
747-01-0034-113	25	33,0 - 35,5	33,4	42	0.5	241.81
747-01-0038-113	32	37,0 - 39,5	38,0	42	0.6	245.39
747-01-0040-113	32	39,5 - 41,8	40,0	42	0.6	246.62
747-01-0042-113	32	42,0 - 44,5	42,2	42	0.6	247.90
747-01-0044-113	32	44,0 - 46,5	44,5	42	0.6	249.13
747-01-0048-113	40	47,5 - 50,5	48,3	42	0.6	252.85
747-01-0050-113	50	49,2 - 51,5	50,8	42	0.6	340.77
747-01-0054-113	50	53,0 - 56,0	54,0	42	0.9	342.51
747-01-0057-113	50	56,0 - 59,0	57,0	42	0.9	344.18
747-01-0060-113	50	59,0 - 62,0	60,3	42	0.9	345.92
747-01-0063-113	50	62,0 - 65,0	63,0	42	0.9	347.65
747-01-0066-113	65	65,4 - 69,0	66,7	37	0.9	370.59
747-01-0069-113	65	68,5 - 72,0	69,0	37	1.0	374.33
747-01-0073-113	65	72,5 - 76,5	73,0	37	1.0	378.05
747-01-0076-113	65	75,0 - 79,0	76,1	37	1.0	381.84
747-01-0079-113	80	78,8 - 83,0	79,9	37	2.0	443.49
747-01-0084-113	80	82,5 - 86,0	84,0	37	2.0	447.90
747-01-0089-113	80	88,0 - 92,0	88,9	37	2.0	452.43
747-01-0101-113	100	100,0 - 104,0	101,6	37	2.1	454.72
747-01-0104-113	100	102,0 - 106,0	104,0	37	2.1	456.93
747-01-0106-113	100	105,0 - 108,0	106,3	37	2.1	463.80
747-01-0108-113	100	106,0 - 110,0	108,0	37	2.1	470.74
747-01-0114-113	100	113,0 - 118,0	114,3	37	2.2	477.85
747-01-0127-113	125	125,0 - 129,0	127,0	37	2.6	541.94
747-01-0129-113	125	127,5 - 131,0	129,0	37	2.6	550.06
747-01-0133-113	125	131,0 - 135,0	131,7	37	2.6	558.35
747-01-0139-113	125	138,0 - 142,0	139,7	37	2.7	566.69
747-01-0141-113	125	139,5 - 144,0	141,3	37	2.7	575.20
747-01-0154-113	150	151,5 - 156,0	154,0	32	2.8	583.84
747-01-0159-113	150	156,0 - 161,0	157,7	32	2.8	592.57
747-01-0165-113	150	164,0 - 168,0	165,2	32	2.9	601.50
747-01-0168-113	150	166,0 - 170,0	168,3	32	2.9	610.52
747-01-0180-113	175	178,0 - 183,0	180,0	26	3.0	619.62
747-01-0200-113	200	198,0 - 203,0	200,0	21	5.9	947.25
747-01-0204-113	200	202,0 - 206,0	204,0	21	5.9	952.00
747-01-0216-113	200	214,0 - 219,0	216,3	21	6.1	956.77
747-01-0219-113	200	216,5 - 222,0	219,1	21	6.1	961.51
747-01-0254-113	225	251,0 - 257,0	254,0	21	6.5	1,264.95
747-01-0267-113	250	262,0 - 270,0	267,4	21	6.6	1,271.24
747-01-0273-113	250	270,0 - 277,0	273,0	21	6.7	1,277.62
747-01-0304-113	275	301,5 - 309,0	304,0	18	7.0	1,349.54
747-01-0318-113	300	316,0 - 323,0	318,5	18	7.2	1,369.79
747-01-0323-113	300	322,0 - 329,0	323,9	18	7.3	1,390.29
747-01-0355-113	350	352,0 - 361,0	355,6	18	7.6	1,505.47
747-01-0406-113	400	402,0 - 411,0	406,4	16	8.3	1,643.52
747-01-0457-113	450	453,0 - 462,0	457,2	16	8.9	1,768.21
747-01-0508-113	500	504,0 - 513,0	508,0	13	9.4	1,893.03
747-01-0558-113	550	555,0 - 564,0	558,8	12	10	2,008.72
747-01-0609-113	600	605,0 - 615,0	609,6	11	11	2,124.60
747-01-0660-113	650	654,0 - 666,0	660,4	10	11	2,249.29
747-01-0711-113	700	705,0 - 717,0	711,2	9	12	2,369.55
747-01-0762-113	750	756,0 - 768,0	762,0	9	12	2,405.08
747-01-0812-113	800	806,0 - 818,0	812,8	9	13	2,614.49
747-01-0863-113	850	857,0 - 869,0	863,6	8	13	2,653.69
747-01-0914-113	900	906,0 - 920,0	914,4	8	14	2,693.48
747-01-1016-113	1000	1010,0 - 1022,0	1016,0	7	15	3,157.92

747/01-114

Repico® RSD
 Repair coupling with two
 locks
 For all pipe types
 Stainless steel



AVK ref. no.	DN mm	Tolerance mm	Pipe dia. mm	Working Pressure bar	Theoretical weight/kg	Gross Price EUR
747-01-0015-114	15	15,3 - 17,0	15,5	42	0.3	329.33
747-01-0020-114	15	19,5 - 21,3	20,0	42	0.3	331.01
747-01-0021-114	15	21,0 - 23,0	21,3	42	0.3	332.62
747-01-0025-114	20	24,0 - 26,5	25,0	42	0.5	334.28
747-01-0027-114	20	26,0 - 28,5	26,7	42	0.5	335.95
747-01-0028-114	25	26,4 - 29,5	28,2	42	0.5	361.73
747-01-0030-114	25	29,0 - 31,5	30,0	42	0.5	363.15
747-01-0032-114	25	31,0 - 33,5	32,0	42	0.5	364.61
747-01-0034-114	25	33,0 - 35,5	33,4	42	0.5	366.03
747-01-0038-114	32	37,0 - 39,5	38,0	42	0.6	393.92
747-01-0040-114	32	39,5 - 41,8	40,0	42	0.6	395.92
747-01-0042-114	32	42,0 - 44,5	42,2	42	0.6	397.92
747-01-0044-114	32	44,0 - 46,5	44,5	42	0.6	399.90
747-01-0048-114	40	47,5 - 50,5	48,3	42	0.6	405.88
747-01-0050-114	50	49,2 - 51,5	50,8	42	0.6	411.99
747-01-0054-114	50	53,0 - 56,0	54,0	42	0.9	643.12
747-01-0057-114	50	56,0 - 59,0	57,0	42	0.9	646.32
747-01-0060-114	50	59,0 - 62,0	60,3	42	0.9	649.53
747-01-0063-114	50	62,0 - 65,0	63,0	42	0.9	652.81
747-01-0066-114	65	65,4 - 69,0	66,7	37	0.9	741.32
747-01-0069-114	65	68,5 - 72,0	69,0	37	1.0	748.71
747-01-0073-114	65	72,5 - 76,5	73,0	37	1.0	756.23
747-01-0076-114	65	75,0 - 79,0	76,1	37	1.0	763.82
747-01-0079-114	80	78,8 - 83,0	79,9	37	2.0	902.93
747-01-0084-114	80	82,5 - 86,0	84,0	37	2.0	912.01
747-01-0089-114	80	88,0 - 92,0	88,9	37	2.0	921.12
747-01-0101-114	100	100,0 - 104,0	101,6	37	2.1	930.36
747-01-0104-114	100	102,0 - 106,0	104,0	37	2.1	1,121.94
747-01-0106-114	100	105,0 - 108,0	106,3	37	2.1	1,127.55
747-01-0108-114	100	106,0 - 110,0	108,0	37	2.1	1,133.19
747-01-0114-114	100	113,0 - 118,0	114,3	37	2.2	1,138.85
747-01-0127-114	125	125,0 - 129,0	127,0	37	2.6	1,144.53
747-01-0129-114	125	127,5 - 131,0	129,0	37	2.6	1,161.70
747-01-0133-114	125	131,0 - 135,0	131,7	37	2.6	1,369.03
747-01-0139-114	125	138,0 - 142,0	139,7	37	2.7	1,389.58
747-01-0141-114	125	139,5 - 144,0	141,3	37	2.7	1,410.42
747-01-0154-114	150	151,5 - 156,0	154,0	32	2.8	1,515.91
747-01-0159-114	150	156,0 - 161,0	157,7	32	2.8	1,538.57
747-01-0165-114	150	164,0 - 168,0	165,2	32	2.9	1,561.72
747-01-0168-114	150	166,0 - 170,0	168,3	32	2.9	1,585.15
747-01-0180-114	175	178,0 - 183,0	180,0	26	3.0	1,642.21
747-01-0200-114	200	198,0 - 203,0	200,0	21	5.9	2,360.87
747-01-0204-114	200	202,0 - 206,0	204,0	21	5.9	2,372.69
747-01-0216-114	200	214,0 - 219,0	216,3	21	6.1	2,384.53
747-01-0219-114	200	216,5 - 222,0	219,1	21	6.1	2,396.46
747-01-0254-114	225	251,0 - 257,0	254,0	21	6.5	2,930.70
747-01-0267-114	250	262,0 - 270,0	267,4	21	6.6	3,406.01
747-01-0273-114	250	270,0 - 277,0	273,0	21	6.7	3,423.04
747-01-0304-114	275	301,5 - 309,0	304,0	18	7.0	3,440.14
747-01-0318-114	300	316,0 - 323,0	318,5	18	7.2	3,990.25
747-01-0323-114	300	322,0 - 329,0	323,9	18	7.3	4,010.24
747-01-0355-114	350	352,0 - 361,0	355,6	18	7.6	4,725.65
747-01-0406-114	400	402,0 - 411,0	406,4	16	8.3	5,285.07
747-01-0457-114	450	453,0 - 462,0	457,2	16	8.9	5,665.51
747-01-0508-114	500	504,0 - 513,0	508,0	13	9.4	6,204.44
747-01-0558-114	550	555,0 - 564,0	558,8	12	10	6,551.83
747-01-0609-114	600	605,0 - 615,0	609,6	11	11	7,108.63
747-01-0660-114	650	654,0 - 666,0	660,4	10	11	7,478.27
747-01-0711-114	700	705,0 - 717,0	711,2	9	12	7,963.78
747-01-0762-114	750	756,0 - 768,0	762,0	9	12	8,083.26
747-01-0812-114	800	806,0 - 818,0	812,8	9	13	8,948.12
747-01-0863-114	850	857,0 - 869,0	863,6	8	13	9,082.32
747-01-0914-114	900	906,0 - 920,0	914,4	8	14	9,218.59
747-01-1016-114	1000	1010,0 - 1022,0	1016,0	7	15	10,970.28

747/02-111

Repico® RSDL
 Repair coupling with two
 locks long version
 for all pipe types
 Stainless steel
 EPDM drinking water
 approved



AVK ref. no.	DN mm	Tolerance mm	Pipe dia. mm	Working Pressure bar	Theoretical weight/kg	Gross Price EUR
747-02-0020-111	15	19,5 - 21,3	20,0	42	0.5	303.56
747-02-0021-111	15	21,0 - 23,0	21,3	42	0.5	308.12
747-02-0025-111	20	24,0 - 26,5	25,0	42	0.6	308.50
747-02-0027-111	20	26,0 - 28,5	26,7	42	0.6	309.42
747-02-0030-111	25	29,0 - 31,5	30,0	42	0.6	309.78
747-02-0032-111	25	31,0 - 33,5	32,0	42	0.6	310.06
747-02-0034-111	25	33,0 - 35,5	33,4	42	0.6	314.69
747-02-0038-111	32	37,0 - 39,5	38,0	42	0.6	315.58
747-02-0040-111	32	39,5 - 41,8	40,0	42	0.6	316.35
747-02-0042-111	32	42,0 - 44,5	42,2	42	0.6	321.11
747-02-0044-111	32	44,0 - 46,5	44,5	42	0.6	322.02
747-02-0048-111	40	47,5 - 50,5	48,3	42	0.7	322.84
747-02-0050-111	50	49,2 - 51,5	50,8	42	0.7	439.76
747-02-0054-111	50	53,0 - 56,0	54,0	42	1.7	441.71
747-02-0057-111	50	56,0 - 59,0	57,0	42	1.7	444.14
747-02-0060-111	50	59,0 - 62,0	60,3	42	1.7	446.38
747-02-0063-111	50	62,0 - 65,0	63,0	42	1.7	453.06
747-02-0069-111	65	68,5 - 72,0	69,0	37	1.8	466.10
747-02-0073-111	65	72,5 - 76,5	73,0	37	1.8	473.11
747-02-0076-111	65	75,0 - 79,0	76,1	37	1.8	480.18
747-02-0084-111	80	82,5 - 86,0	84,0	37	3.5	577.62
747-02-0089-111	80	88,0 - 92,0	88,9	37	3.6	578.66
747-02-0101-111	100	100,0 - 104,0	101,6	37	3.7	599.34
747-02-0104-111	100	102,0 - 106,0	104,0	37	3.8	619.96
747-02-0106-111	100	105,0 - 108,0	106,3	37	3.8	629.28
747-02-0108-111	100	106,0 - 110,0	108,0	37	3.8	638.69
747-02-0114-111	100	113,0 - 118,0	114,3	37	3.9	648.26
747-02-0127-111	125	125,0 - 129,0	127,0	37	4.7	752.65
747-02-0133-111	125	131,0 - 135,0	131,7	37	4.7	755.47
747-02-0139-111	125	138,0 - 142,0	139,7	37	4.8	758.23
747-02-0141-111	125	139,5 - 144,0	141,3	37	4.8	762.01
747-02-0154-111	150	151,5 - 156,0	154,0	32	5.0	764.24
747-02-0159-111	150	156,0 - 161,0	157,7	32	5.1	767.03
747-02-0165-111	150	164,0 - 168,0	165,2	32	5.2	778.61
747-02-0168-111	150	166,0 - 170,0	168,3	32	5.2	790.24
747-02-0216-111	200	214,0 - 219,0	216,3	21	13	1,367.08
747-02-0219-111	200	216,5 - 222,0	219,1	21	13	1,380.71
747-02-0267-111	250	262,0 - 270,0	267,4	21	14	1,794.95
747-02-0273-111	250	270,0 - 277,0	273,0	21	14	1,812.88
747-02-0318-111	300	316,0 - 323,0	318,5	18	15	1,897.40
747-02-0323-111	300	322,0 - 329,0	323,9	18	15	1,925.80
747-02-0355-111	350	352,0 - 361,0	355,6	18	16	2,155.77
747-02-0406-111	400	402,0 - 411,0	406,4	16	17	2,280.46
747-02-0457-111	450	453,0 - 462,0	457,2	16	18	2,405.20
747-02-0508-111	500	504,0 - 513,0	508,0	13	19	2,529.89
747-02-0558-111	550	555,0 - 564,0	558,8	12	20	2,654.59
747-02-0609-111	600	605,0 - 615,0	609,6	11	21	2,783.72
747-02-0660-111	650	654,0 - 666,0	660,4	10	22	2,926.27
747-02-0711-111	700	705,0 - 717,0	711,2	9	23	3,059.91
747-02-0762-111	750	756,0 - 768,0	762,0	9	24	3,105.80
747-02-0812-111	800	806,0 - 818,0	812,8	9	25	3,336.01
747-02-0863-111	850	857,0 - 869,0	863,6	8	26	3,386.08
747-02-0914-111	900	906,0 - 920,0	914,4	8	27	3,436.86
747-02-1016-111	1000	1010,0 - 1022,0	1016,0	7	29	3,879.43

747/02-112

Repico® RSDL
 Repair coupling with two
 locks long version
 For all pipe types
 Stainless steel
 NBR rubber



AVK ref. no.	DN mm	Tolerance mm	Pipe dia. mm	Working Pressure bar	Theoretical weight/kg	Gross Price EUR
747-02-0020-112	15	19,5 - 21,3	20,0	42	0.5	303.56
747-02-0021-112	15	21,0 - 23,0	21,3	42	0.5	308.12
747-02-0025-112	20	24,0 - 26,5	25,0	42	0.6	308.50
747-02-0027-112	20	26,0 - 28,5	26,7	42	0.6	309.42
747-02-0030-112	25	29,0 - 31,5	30,0	42	0.6	309.78
747-02-0032-112	25	31,0 - 33,5	32,0	42	0.6	310.06
747-02-0034-112	25	33,0 - 35,5	33,4	42	0.6	314.69
747-02-0038-112	32	37,0 - 39,5	38,0	42	0.6	315.58
747-02-0040-112	32	39,5 - 41,8	40,0	42	0.6	316.35
747-02-0042-112	32	42,0 - 44,5	42,2	42	0.6	321.11
747-02-0044-112	32	44,0 - 46,5	44,5	42	0.6	322.02
747-02-0048-112	40	47,5 - 50,5	48,3	42	0.7	322.84
747-02-0050-112	50	49,2 - 51,5	50,8	42	0.7	439.76
747-02-0054-112	50	53,0 - 56,0	54,0	42	1.7	441.71
747-02-0057-112	50	56,0 - 59,0	57,0	42	1.7	444.14
747-02-0060-112	50	59,0 - 62,0	60,3	42	1.7	446.38
747-02-0063-112	50	62,0 - 65,0	63,0	42	1.7	453.06
747-02-0069-112	65	68,5 - 72,0	69,0	37	1.8	466.10
747-02-0073-112	65	72,5 - 76,5	73,0	37	1.8	473.11
747-02-0076-112	65	75,0 - 79,0	76,1	37	1.8	480.18
747-02-0084-112	80	82,5 - 86,0	84,0	37	3.5	577.62
747-02-0089-112	80	88,0 - 92,0	88,9	37	3.6	578.66
747-02-0101-112	100	100,0 - 104,0	101,6	37	3.7	599.34
747-02-0104-112	100	102,0 - 106,0	104,0	37	3.8	619.96
747-02-0106-112	100	105,0 - 108,0	106,3	37	3.8	629.28
747-02-0108-112	100	106,0 - 110,0	108,0	37	3.8	638.69
747-02-0114-112	100	113,0 - 118,0	114,3	37	3.9	648.26
747-02-0127-112	125	125,0 - 129,0	127,0	37	4.7	752.65
747-02-0133-112	125	131,0 - 135,0	131,7	37	4.7	755.47
747-02-0139-112	125	138,0 - 142,0	139,7	37	4.8	758.23
747-02-0141-112	125	139,5 - 144,0	141,3	37	4.8	762.01
747-02-0154-112	150	151,5 - 156,0	154,0	32	5.0	764.24
747-02-0159-112	150	156,0 - 161,0	157,7	32	5.1	767.03
747-02-0165-112	150	164,0 - 168,0	165,2	32	5.2	778.61
747-02-0168-112	150	166,0 - 170,0	168,3	32	5.2	790.24
747-02-0216-112	200	214,0 - 219,0	216,3	21	13	1,367.08
747-02-0219-112	200	216,5 - 222,0	219,1	21	13	1,380.71
747-02-0267-112	250	262,0 - 270,0	267,4	21	14	1,794.95
747-02-0273-112	250	270,0 - 277,0	273,0	21	14	1,812.88
747-02-0318-112	300	316,0 - 323,0	318,5	18	15	1,897.40
747-02-0323-112	300	322,0 - 329,0	323,9	18	15	1,925.80
747-02-0355-112	350	352,0 - 361,0	355,6	18	16	2,155.77
747-02-0406-112	400	402,0 - 411,0	406,4	16	17	2,280.46
747-02-0457-112	450	453,0 - 462,0	457,2	16	18	2,405.20
747-02-0508-112	500	504,0 - 513,0	508,0	13	19	2,529.89
747-02-0558-112	550	555,0 - 564,0	558,8	12	20	2,654.59
747-02-0609-112	600	605,0 - 615,0	609,6	11	21	2,783.72
747-02-0660-112	650	654,0 - 666,0	660,4	10	22	2,926.27
747-02-0711-112	700	705,0 - 717,0	711,2	9	23	3,059.91
747-02-0762-112	750	756,0 - 768,0	762,0	9	24	3,105.80
747-02-0812-112	800	806,0 - 818,0	812,8	9	25	3,336.01
747-02-0863-112	850	857,0 - 869,0	863,6	8	26	3,386.08
747-02-0914-112	900	906,0 - 920,0	914,4	8	27	3,436.86
747-02-1016-112	1000	1010,0 - 1022,0	1016,0	7	29	3,879.43

747/02-113

Repico® RSDL
 Repair coupling with two
 locks long version
 For all pipe types
 Stainless steel
 Silicone rubber



AVK ref. no.	DN mm	Tolerance mm	Pipe dia. mm	Working Pressure bar	Theoretical weight/kg	Gross Price EUR
747-02-0020-113	15	19,5 - 21,3	20,0	42	0.5	310.06
747-02-0021-113	15	21,0 - 23,0	21,3	42	0.5	314.69
747-02-0025-113	20	24,0 - 26,5	25,0	42	0.6	335.82
747-02-0027-113	20	26,0 - 28,5	26,7	42	0.6	336.80
747-02-0032-113	25	31,0 - 33,5	32,0	42	0.6	342.26
747-02-0034-113	25	33,0 - 35,5	33,4	42	0.6	347.39
747-02-0040-113	32	39,5 - 41,8	40,0	42	0.6	347.77
747-02-0042-113	32	42,0 - 44,5	42,2	42	0.6	348.10
747-02-0048-113	40	47,5 - 50,5	48,3	42	0.7	348.75
747-02-0050-113	50	49,2 - 51,5	50,8	42	0.7	549.67
747-02-0060-113	50	59,0 - 62,0	60,3	42	1.7	557.89
747-02-0063-113	50	62,0 - 65,0	63,0	42	1.7	566.24
747-02-0069-113	65	68,5 - 72,0	69,0	37	1.8	600.89
747-02-0073-113	65	72,5 - 76,5	73,0	37	1.8	609.89
747-02-0076-113	65	75,0 - 79,0	76,1	37	1.8	612.97
747-02-0089-113	80	88,0 - 92,0	88,9	37	3.6	739.27
747-02-0101-113	100	100,0 - 104,0	101,6	37	3.7	742.97
747-02-0104-113	100	102,0 - 106,0	104,0	37	3.8	746.68
747-02-0106-113	100	105,0 - 108,0	106,3	37	3.8	757.84
747-02-0108-113	100	106,0 - 110,0	108,0	37	3.8	769.19
747-02-0114-113	100	113,0 - 118,0	114,3	37	3.9	780.76
747-02-0139-113	125	138,0 - 142,0	139,7	37	4.8	904.85
747-02-0141-113	125	139,5 - 144,0	141,3	37	4.8	918.43
747-02-0159-113	150	156,0 - 161,0	157,7	32	5.1	926.08
747-02-0165-113	150	164,0 - 168,0	165,2	32	5.2	939.95
747-02-0168-113	150	166,0 - 170,0	168,3	32	5.2	954.06
747-02-0216-113	200	214,0 - 219,0	216,3	21	13	1,636.14
747-02-0219-113	200	216,5 - 222,0	219,1	21	13	1,652.52
747-02-0267-113	250	262,0 - 270,0	267,4	21	14	2,169.07
747-02-0273-113	250	270,0 - 277,0	273,0	21	14	2,190.74
747-02-0318-113	300	316,0 - 323,0	318,5	18	15	2,311.63
747-02-0323-113	300	322,0 - 329,0	323,9	18	15	2,346.28
747-02-0355-113	350	352,0 - 361,0	355,6	18	16	2,645.72
747-02-0406-113	400	402,0 - 411,0	406,4	16	17	2,797.09
747-02-0457-113	450	453,0 - 462,0	457,2	16	18	2,966.38
747-02-0508-113	500	504,0 - 513,0	508,0	13	19	3,144.48
747-02-0558-113	550	555,0 - 564,0	558,8	12	20	3,322.71
747-02-0609-113	600	605,0 - 615,0	609,6	11	21	3,509.74
747-02-0660-113	650	654,0 - 666,0	660,4	10	22	3,696.84
747-02-0711-113	700	705,0 - 717,0	711,2	9	23	3,883.87
747-02-0762-113	750	756,0 - 768,0	762,0	9	24	3,942.16
747-02-0812-113	800	806,0 - 818,0	812,8	9	25	4,262.50
747-02-0863-113	850	857,0 - 869,0	863,6	8	26	4,326.38
747-02-0914-113	900	906,0 - 920,0	914,4	8	27	4,391.32
747-02-1016-113	1000	1010,0 - 1022,0	1016,0	7	29	5,006.26

747/11-111

Repico® RSDF
 Repair coupling with two
 locks for high pressure
 for all pipe types
 Stainless steel
 EPDM drinking water
 approved



AVK ref. no.	DN mm	Tolerance mm	Pipe dia. mm	Working Pressure bar	Theoretical weight/kg	Gross Price EUR
747-11-0076-111	65	75,0 - 79,0	76,1	42	1.1	416.18
747-11-0079-111	80	78,8 - 83,0	79,9	42	2.2	416.94
747-11-0084-111	80	82,5 - 86,0	84,0	42	2.3	423.20
747-11-0089-111	80	88,0 - 92,0	88,9	42	2.3	429.55
747-11-0101-111	100	100,0 - 104,0	101,6	42	2.4	434.32
747-11-0104-111	100	102,0 - 106,0	104,0	42	2.4	451.79
747-11-0106-111	100	105,0 - 108,0	106,3	42	2.4	458.54
747-11-0108-111	100	106,0 - 110,0	108,0	42	2.4	465.40
747-11-0114-111	100	113,0 - 118,0	114,3	42	2.5	472.42
747-11-0127-111	125	125,0 - 129,0	127,0	42	3.3	634.34
747-11-0129-111	125	127,5 - 131,0	129,0	42	3.3	643.88
747-11-0133-111	125	131,0 - 135,0	131,7	42	3.3	653.48
747-11-0139-111	125	138,0 - 142,0	139,7	42	3.4	660.00
747-11-0141-111	125	139,5 - 144,0	141,3	42	3.4	666.60
747-11-0154-111	150	151,5 - 156,0	154,0	42	3.6	671.68
747-11-0159-111	150	156,0 - 161,0	157,7	42	3.6	681.82
747-11-0165-111	150	164,0 - 168,0	165,2	42	3.7	691.99
747-11-0168-111	150	166,0 - 170,0	168,3	42	3.7	702.35
747-11-0180-111	175	178,0 - 183,0	180,0	42	3.8	873.55
747-11-0200-111	200	198,0 - 203,0	200,0	32	7.2	1,023.00
747-11-0204-111	200	202,0 - 206,0	204,0	32	7.3	1,038.41
747-11-0216-111	200	214,0 - 219,0	216,3	32	7.5	1,053.93
747-11-0219-111	200	216,5 - 222,0	219,1	32	7.5	1,069.76
747-11-0254-111	225	251,0 - 257,0	254,0	26	8.0	1,246.25
747-11-0267-111	250	262,0 - 270,0	267,4	26	8.3	1,264.95
747-11-0273-111	250	270,0 - 277,0	273,0	26	8.3	1,283.90
747-11-0304-111	275	301,5 - 309,0	304,0	26	8.8	1,338.34
747-11-0318-111	300	316,0 - 323,0	318,5	26	9.0	1,358.47
747-11-0323-111	300	322,0 - 329,0	323,9	26	9.1	1,370.69
747-11-0355-111	350	352,0 - 361,0	355,6	26	9.6	1,500.19
747-11-0406-111	400	402,0 - 411,0	406,4	26	10	1,612.35
747-11-0457-111	450	453,0 - 462,0	457,2	25	11	1,714.79
747-11-0508-111	500	504,0 - 513,0	508,0	18	12	1,812.82
747-11-0558-111	550	555,0 - 564,0	558,8	18	13	1,906.34
747-11-0609-111	600	605,0 - 615,0	609,6	16	13	1,999.85
747-11-0660-111	650	654,0 - 666,0	660,4	16	14	2,106.73
747-11-0711-111	700	705,0 - 717,0	711,2	14	15	2,200.33
747-11-0762-111	750	756,0 - 768,0	762,0	14	16	2,298.34
747-11-0812-111	800	806,0 - 818,0	812,8	13	17	2,405.20
747-11-0863-111	850	857,0 - 869,0	863,6	12	17	2,516.47
747-11-0914-111	900	906,0 - 920,0	914,4	11	18	2,632.35
747-11-1016-111	1000	1010,0 - 1022,0	1016,0	10	20	2,899.53

747/11-112

Repico® RSDF
 Repair coupling with two
 locks for high pressure
 For all pipe types
 Stainless steel
 NBR rubber



AVK ref. no.	DN mm	Tolerance mm	Pipe dia. mm	Working Pressure bar	Theoretical weight/kg	Gross Price EUR
747-11-0076-112	65	75,0 - 79,0	76,1	42	1.1	416.18
747-11-0079-112	80	78,8 - 83,0	79,9	42	2.2	416.94
747-11-0084-112	80	82,5 - 86,0	84,0	42	2.3	423.20
747-11-0089-112	80	88,0 - 92,0	88,9	42	2.3	429.55
747-11-0101-112	100	100,0 - 104,0	101,6	42	2.4	434.32
747-11-0104-112	100	102,0 - 106,0	104,0	42	2.4	451.79
747-11-0106-112	100	105,0 - 108,0	106,3	42	2.4	458.54
747-11-0108-112	100	106,0 - 110,0	108,0	42	2.4	465.40
747-11-0114-112	100	113,0 - 118,0	114,3	42	2.5	472.42
747-11-0127-112	125	125,0 - 129,0	127,0	42	3.3	634.34
747-11-0129-112	125	127,5 - 131,0	129,0	42	3.3	643.88
747-11-0133-112	125	131,0 - 135,0	131,7	42	3.3	653.48
747-11-0139-112	125	138,0 - 142,0	139,7	42	3.4	660.00
747-11-0141-112	125	139,5 - 144,0	141,3	42	3.4	666.60
747-11-0154-112	150	151,5 - 156,0	154,0	42	3.6	671.68
747-11-0159-112	150	156,0 - 161,0	157,7	42	3.6	681.82
747-11-0165-112	150	164,0 - 168,0	165,2	42	3.7	691.99
747-11-0168-112	150	166,0 - 170,0	168,3	42	3.7	702.35
747-11-0180-112	175	178,0 - 183,0	180,0	42	3.8	873.55
747-11-0200-112	200	198,0 - 203,0	200,0	32	7.2	1,023.00
747-11-0204-112	200	202,0 - 206,0	204,0	32	7.3	1,038.41
747-11-0216-112	200	214,0 - 219,0	216,3	32	7.5	1,053.93
747-11-0219-112	200	216,5 - 222,0	219,1	32	7.5	1,069.76
747-11-0254-112	225	251,0 - 257,0	254,0	26	8.0	1,246.25
747-11-0267-112	250	262,0 - 270,0	267,4	26	8.3	1,264.95
747-11-0273-112	250	270,0 - 277,0	273,0	26	8.3	1,283.90
747-11-0304-112	275	301,5 - 309,0	304,0	26	8.8	1,338.34
747-11-0318-112	300	316,0 - 323,0	318,5	26	9.0	1,358.47
747-11-0323-112	300	322,0 - 329,0	323,9	26	9.1	1,370.69
747-11-0355-112	350	352,0 - 361,0	355,6	26	9.6	1,500.19
747-11-0406-112	400	402,0 - 411,0	406,4	26	10	1,612.35
747-11-0457-112	450	453,0 - 462,0	457,2	25	11	1,714.79
747-11-0508-112	500	504,0 - 513,0	508,0	18	12	1,812.82
747-11-0558-112	550	555,0 - 564,0	558,8	18	13	1,906.34
747-11-0609-112	600	605,0 - 615,0	609,6	16	13	1,999.85
747-11-0660-112	650	654,0 - 666,0	660,4	16	14	2,106.73
747-11-0711-112	700	705,0 - 717,0	711,2	14	15	2,200.33
747-11-0762-112	750	756,0 - 768,0	762,0	14	16	2,298.34
747-11-0812-112	800	806,0 - 818,0	812,8	13	17	2,405.20
747-11-0863-112	850	857,0 - 869,0	863,6	12	17	2,516.47
747-11-0914-112	900	906,0 - 920,0	914,4	11	18	2,632.35
747-11-1016-112	1000	1010,0 - 1022,0	1016,0	10	20	2,899.53

747/12-111

Repico® RSDFL
Repair coupling with two
locks long version for high
pressure
For all pipe types
Stainless steel
EPDM drinking water
approved



Note: Repico® Slip couplings
are also available in three or
four locks.
Please contact our sales
department for more
information.
Tel. +31 (0)578 560 602

AVK ref. no.	DN mm	Tolerance mm	Pipe dia. mm	Working Pressure bar	Theoretical weight/kg	Gross Price EUR
747-12-0089-111	80	88,0 - 92,0	88,9	42	4.0	634.76
747-12-0101-111	100	100,0 - 104,0	101,6	42	4.2	655.66
747-12-0104-111	100	102,0 - 106,0	104,0	42	4.2	680.73
747-12-0106-111	100	105,0 - 108,0	106,3	42	4.2	690.94
747-12-0108-111	100	106,0 - 110,0	108,0	42	4.2	701.29
747-12-0114-111	100	113,0 - 118,0	114,3	42	4.3	711.83
747-12-0139-111	125	138,0 - 142,0	139,7	42	6.0	1,034.23
747-12-0141-111	125	139,5 - 144,0	141,3	42	6.0	1,049.73
747-12-0159-111	150	156,0 - 161,0	157,7	42	6.3	1,065.48
747-12-0165-111	150	164,0 - 168,0	165,2	42	6.5	1,081.46
747-12-0168-111	150	166,0 - 170,0	168,3	42	6.5	1,097.71
747-12-0216-111	200	214,0 - 219,0	216,3	32	16	1,697.05
747-12-0219-111	200	216,5 - 222,0	219,1	32	16	1,722.51
747-12-0267-111	250	262,0 - 270,0	267,4	26	17	2,231.49
747-12-0273-111	250	270,0 - 277,0	273,0	26	17	2,264.97
747-12-0318-111	300	316,0 - 323,0	318,5	26	18	2,351.73
747-12-0323-111	300	322,0 - 329,0	323,9	26	18	2,386.96
747-12-0355-111	350	352,0 - 361,0	355,6	26	19	2,672.45
747-12-0406-111	400	402,0 - 411,0	406,4	26	20	2,841.69
747-12-0457-111	450	453,0 - 462,0	457,2	25	22	2,997.55
747-12-0508-111	500	504,0 - 513,0	508,0	18	23	3,126.67
747-12-0558-111	550	555,0 - 564,0	558,8	18	24	3,318.26
747-12-0609-111	600	605,0 - 615,0	609,6	16	26	3,474.14
747-12-0660-111	650	654,0 - 666,0	660,4	16	27	3,656.73
747-12-0711-111	700	705,0 - 717,0	711,2	14	28	3,826.03
747-12-0762-111	750	756,0 - 768,0	762,0	14	29	4,008.63
747-12-0812-111	800	806,0 - 818,0	812,8	13	31	4,182.36
747-12-0863-111	850	857,0 - 869,0	863,6	12	32	4,356.02
747-12-0914-111	900	906,0 - 920,0	914,4	11	33	4,516.39
747-12-1016-111	1000	1010,0 - 1022,0	1016,0	10	36	4,859.34

747/12-112

Repico® RSDFL
Repair coupling with two
locks long version for high
pressure
For all pipe types
Stainless steel
NBR rubber



Note: Repico® Slip couplings
are also available in three or
four locks.
Please contact our sales
department for more
information.
Tel. +31 (0)578 560 602

AVK ref. no.	DN mm	Tolerance mm	Pipe dia. mm	Working Pressure bar	Theoretical weight/kg	Gross Price EUR
747-12-0089-112	80	88,0 - 92,0	88,9	42	4.0	634.76
747-12-0101-112	100	100,0 - 104,0	101,6	42	4.2	655.66
747-12-0104-112	100	102,0 - 106,0	104,0	42	4.2	680.73
747-12-0106-112	100	105,0 - 108,0	106,3	42	4.2	690.94
747-12-0108-112	100	106,0 - 110,0	108,0	42	4.2	701.29
747-12-0114-112	100	113,0 - 118,0	114,3	42	4.3	711.83
747-12-0139-112	125	138,0 - 142,0	139,7	42	6.0	1,034.23
747-12-0141-112	125	139,5 - 144,0	141,3	42	6.0	1,049.73
747-12-0159-112	150	156,0 - 161,0	157,7	42	6.3	1,065.48
747-12-0165-112	150	164,0 - 168,0	165,2	42	6.5	1,081.46
747-12-0168-112	150	166,0 - 170,0	168,3	42	6.5	1,097.71
747-12-0216-112	200	214,0 - 219,0	216,3	32	16	1,697.05
747-12-0219-112	200	216,5 - 222,0	219,1	32	16	1,722.51
747-12-0267-112	250	262,0 - 270,0	267,4	26	17	2,231.49
747-12-0273-112	250	270,0 - 277,0	273,0	26	17	2,264.97
747-12-0318-112	300	316,0 - 323,0	318,5	26	18	2,351.73
747-12-0323-112	300	322,0 - 329,0	323,9	26	18	2,386.96
747-12-0355-112	350	352,0 - 361,0	355,6	26	19	2,672.45
747-12-0406-112	400	402,0 - 411,0	406,4	26	20	2,841.69
747-12-0457-112	450	453,0 - 462,0	457,2	25	22	2,997.55
747-12-0508-112	500	504,0 - 513,0	508,0	18	23	3,126.67
747-12-0558-112	550	555,0 - 564,0	558,8	18	24	3,318.26
747-12-0609-112	600	605,0 - 615,0	609,6	16	26	3,474.14
747-12-0660-112	650	654,0 - 666,0	660,4	16	27	3,656.73
747-12-0711-112	700	705,0 - 717,0	711,2	14	28	3,826.03
747-12-0762-112	750	756,0 - 768,0	762,0	14	29	4,008.63
747-12-0812-112	800	806,0 - 818,0	812,8	13	31	4,182.36
747-12-0863-112	850	857,0 - 869,0	863,6	12	32	4,356.02
747-12-0914-112	900	906,0 - 920,0	914,4	11	33	4,516.39
747-12-1016-112	1000	1010,0 - 1022,0	1016,0	10	36	4,859.34

747/71-111

Repico® RE
 Repair coupling for elbows
 For repair of elbows, bends or
 welds
 Stainless steel
 EPDM drinking water
 approved



AVK ref. no.	DN mm	Tolerance mm	Pipe dia. mm	Working Pressure bar	Theoretical weight/kg	Gross Price EUR
747-71-0015-111	15	15,3 - 17,0	15,5	53	0.2	106.50
747-71-0020-111	15	19,5 - 21,3	20,0	46	0.2	108.11
747-71-0021-111	15	21,0 - 23,0	21,3	46	0.2	109.73
747-71-0025-111	20	24,0 - 26,5	25,0	46	0.2	109.84
747-71-0027-111	20	26,0 - 28,5	26,7	46	0.2	111.44
747-71-0028-111	25	26,4 - 29,5	28,2	46	0.2	113.00
747-71-0030-111	25	29,0 - 31,5	30,0	46	0.2	113.58
747-71-0032-111	25	31,0 - 33,5	32,0	46	0.2	114.15
747-71-0034-111	25	33,0 - 35,5	33,4	46	0.2	114.73
747-71-0038-111	32	37,0 - 39,5	38,0	46	0.2	116.27
747-71-0040-111	32	39,5 - 41,8	40,0	46	0.2	118.07
747-71-0042-111	32	42,0 - 44,5	42,2	46	0.2	119.80
747-71-0044-111	32	44,0 - 46,5	44,5	40	0.2	121.61
747-71-0048-111	40	47,5 - 50,5	48,3	40	0.2	123.40
747-71-0050-111	50	49,2 - 51,5	50,8	40	0.2	148.33
747-71-0054-111	50	53,0 - 56,0	54,0	40	0.5	149.12
747-71-0057-111	50	56,0 - 59,0	57,0	40	0.5	149.81
747-71-0060-111	50	59,0 - 62,0	60,3	40	0.5	150.58
747-71-0063-111	50	62,0 - 65,0	63,0	40	0.5	151.35
747-71-0066-111	65	65,4 - 69,0	66,7	40	0.5	157.34
747-71-0069-111	65	68,5 - 72,0	69,0	40	0.5	159.65
747-71-0073-111	65	72,5 - 76,5	73,0	40	0.5	162.09
747-71-0076-111	65	75,0 - 79,0	76,1	40	0.6	164.47
747-71-0079-111	80	78,8 - 83,0	79,9	40	1.2	165.37
747-71-0084-111	80	82,5 - 86,0	84,0	40	1.3	167.81
747-71-0089-111	80	88,0 - 92,0	88,9	40	1.3	170.32
747-71-0101-111	100	100,0 - 104,0	101,6	33	1.3	172.20
747-71-0104-111	100	102,0 - 106,0	104,0	33	1.3	179.14
747-71-0106-111	100	105,0 - 108,5	106,3	33	1.3	181.76
747-71-0108-111	100	106,0 - 110,0	108,0	33	1.3	184.52
747-71-0114-111	100	113,0 - 118,0	114,3	33	1.3	187.29
747-71-0127-111	125	125,0 - 129,5	127,0	24	1.4	209.46
747-71-0129-111	125	127,5 - 131,0	129,0	24	1.4	212.62
747-71-0133-111	125	131,0 - 135,5	131,7	24	1.4	215.77
747-71-0139-111	125	138,0 - 142,5	139,7	24	1.4	219.03
747-71-0141-111	125	139,5 - 144,0	141,3	24	1.4	222.32
747-71-0154-111	150	151,5 - 156,0	154,0	24	1.5	223.42
747-71-0159-111	150	156,0 - 161,0	157,7	24	1.5	226.74
747-71-0165-111	150	164,0 - 168,5	165,2	24	1.5	230.15
747-71-0168-111	150	166,0 - 170,5	168,3	24	1.5	233.63
747-71-0180-111	175	178,0 - 183,0	180,0	21	1.5	237.09
747-71-0200-111	200	198,0 - 203,5	200,0	21	1.9	308.58
747-71-0204-111	200	202,0 - 206,5	204,0	21	2.0	313.19
747-71-0216-111	200	214,0 - 219,0	216,3	21	2.0	317.90
747-71-0219-111	200	216,5 - 222,0	219,1	21	2.0	322.65
747-71-0254-111	225	251,0 - 257,0	254,0	21	2.1	445.41
747-71-0267-111	250	262,0 - 270,0	267,4	21	2.2	452.11
747-71-0273-111	250	270,0 - 277,0	273,0	21	2.2	458.84
747-71-0304-111	275	301,5 - 309,0	304,0	17	2.3	507.75
747-71-0318-111	300	316,0 - 323,0	318,5	17	2.4	515.35
747-71-0323-111	300	322,0 - 329,0	323,9	17	2.4	523.12
747-71-0355-111	350	352,0 - 361,0	355,6	16	2.5	601.28
747-71-0406-111	400	402,0 - 411,0	406,4	14	2.7	650.31
747-71-0457-111	450	453,0 - 462,0	457,2	13	2.9	703.72
747-71-0508-111	500	504,0 - 513,0	508,0	12	3.1	757.20

747/71-112

Repico® RE
 Repair coupling for elbows
 For repair of elbows, bends or
 welds
 Stainless steel
 NBR rubber



AVK ref. no.	DN mm	Tolerance mm	Pipe dia. mm	Working Pressure bar	Theoretical weight/kg	Gross Price EUR
747-71-0015-112	15	15,3 - 17,0	15,5	53	0.2	106.50
747-71-0020-112	15	19,5 - 21,3	20,0	46	0.2	108.11
747-71-0021-112	15	21,0 - 23,0	21,3	46	0.2	109.73
747-71-0025-112	20	24,0 - 26,5	25,0	46	0.2	109.84
747-71-0027-112	20	26,0 - 28,5	26,7	46	0.2	111.44
747-71-0028-112	25	26,4 - 29,5	28,2	46	0.2	113.00
747-71-0030-112	25	29,0 - 31,5	30,0	46	0.2	113.58
747-71-0032-112	25	31,0 - 33,5	32,0	46	0.2	114.15
747-71-0034-112	25	33,0 - 35,5	33,4	46	0.2	114.73
747-71-0038-112	32	37,0 - 39,5	38,0	46	0.2	116.27
747-71-0040-112	32	39,5 - 41,8	40,0	46	0.2	118.07
747-71-0042-112	32	42,0 - 44,5	42,2	46	0.2	119.80
747-71-0044-112	32	44,0 - 46,5	44,5	40	0.2	121.61
747-71-0048-112	40	47,5 - 50,5	48,3	40	0.2	123.40
747-71-0050-112	50	49,2 - 51,5	50,8	40	0.2	148.33
747-71-0054-112	50	53,0 - 56,0	54,0	40	0.5	149.12
747-71-0057-112	50	56,0 - 59,0	57,0	40	0.5	149.81
747-71-0060-112	50	59,0 - 62,0	60,3	40	0.5	150.58
747-71-0063-112	50	62,0 - 65,0	63,0	40	0.5	151.35
747-71-0066-112	65	65,4 - 69,0	66,7	40	0.5	157.34
747-71-0069-112	65	68,5 - 72,0	69,0	40	0.5	159.65
747-71-0073-112	65	72,5 - 76,5	73,0	40	0.5	162.09
747-71-0076-112	65	75,0 - 79,0	76,1	40	0.6	164.47
747-71-0079-112	80	78,8 - 83,0	79,9	40	1.2	165.37
747-71-0084-112	80	82,5 - 86,0	84,0	40	1.3	167.81
747-71-0089-112	80	88,0 - 92,0	88,9	40	1.3	170.32
747-71-0101-112	100	100,0 - 104,0	101,6	33	1.3	172.20
747-71-0104-112	100	102,0 - 106,0	104,0	33	1.3	179.14
747-71-0106-112	100	105,0 - 108,5	106,3	33	1.3	181.76
747-71-0108-112	100	106,0 - 110,0	108,0	33	1.3	184.52
747-71-0114-112	100	113,0 - 118,0	114,3	33	1.3	187.29
747-71-0127-112	125	125,0 - 129,5	127,0	24	1.4	209.46
747-71-0129-112	125	127,5 - 131,0	129,0	24	1.4	212.62
747-71-0133-112	125	131,0 - 135,5	131,7	24	1.4	215.77
747-71-0139-112	125	138,0 - 142,5	139,7	24	1.4	219.03
747-71-0141-112	125	139,5 - 144,0	141,3	24	1.4	222.32
747-71-0154-112	150	151,5 - 156,0	154,0	24	1.5	223.42
747-71-0159-112	150	156,0 - 161,0	157,7	24	1.5	226.74
747-71-0165-112	150	164,0 - 168,5	165,2	24	1.5	230.15
747-71-0168-112	150	166,0 - 170,5	168,3	24	1.5	233.63
747-71-0180-112	175	178,0 - 183,0	180,0	21	1.5	237.09
747-71-0200-112	200	198,0 - 203,5	200,0	21	1.9	308.58
747-71-0204-112	200	202,0 - 206,5	204,0	21	2.0	313.19
747-71-0216-112	200	214,0 - 219,0	216,3	21	2.0	317.90
747-71-0219-112	200	216,5 - 222,0	219,1	21	2.0	322.65
747-71-0254-112	225	251,0 - 257,0	254,0	21	2.1	445.41
747-71-0267-112	250	262,0 - 270,0	267,4	21	2.2	452.11
747-71-0273-112	250	270,0 - 277,0	273,0	21	2.2	458.84
747-71-0304-112	275	301,5 - 309,0	304,0	17	2.3	507.75
747-71-0318-112	300	316,0 - 323,0	318,5	17	2.4	515.35
747-71-0323-112	300	322,0 - 329,0	323,9	17	2.4	523.12
747-71-0355-112	350	352,0 - 361,0	355,6	16	2.5	601.28
747-71-0406-112	400	402,0 - 411,0	406,4	14	2.7	650.31
747-71-0457-112	450	453,0 - 462,0	457,2	13	2.9	703.72
747-71-0508-112	500	504,0 - 513,0	508,0	12	3.1	757.20

747/71-113

Repico® RE
 Repair coupling for elbows
 For repair of elbows, bends or
 welds
 Stainless steel
 Silicone rubber



AVK ref. no.	DN mm	Tolerance mm	Pipe dia. mm	Working Pressure bar	Theoretical weight/kg	Gross Price EUR
747-71-0015-113	15	15,3 - 17,0	15,5	53	0.2	113.89
747-71-0020-113	15	19,5 - 21,3	20,0	46	0.2	115.56
747-71-0021-113	15	21,0 - 23,0	21,3	46	0.2	117.30
747-71-0025-113	20	24,0 - 26,5	25,0	46	0.2	117.43
747-71-0027-113	20	26,0 - 28,5	26,7	46	0.2	118.65
747-71-0028-113	25	26,4 - 29,5	28,2	46	0.2	118.84
747-71-0030-113	25	29,0 - 31,5	30,0	46	0.2	119.41
747-71-0032-113	25	31,0 - 33,5	32,0	46	0.2	119.99
747-71-0034-113	25	33,0 - 35,5	33,4	46	0.2	120.63
747-71-0038-113	32	37,0 - 39,5	38,0	46	0.2	120.63
747-71-0040-113	32	39,5 - 41,8	40,0	46	0.2	121.29
747-71-0042-113	32	42,0 - 44,5	42,2	46	0.2	121.87
747-71-0044-113	32	44,0 - 46,5	44,5	40	0.2	122.51
747-71-0048-113	40	47,5 - 50,5	48,3	40	0.2	123.08
747-71-0050-113	50	49,2 - 51,5	50,8	40	0.2	123.73
747-71-0054-113	50	53,0 - 56,0	54,0	40	0.5	159.39
747-71-0057-113	50	56,0 - 59,0	57,0	40	0.5	160.17
747-71-0060-113	50	59,0 - 62,0	60,3	40	0.5	160.99
747-71-0063-113	50	62,0 - 65,0	63,0	40	0.5	161.79
747-71-0066-113	65	65,4 - 69,0	66,7	40	0.5	168.46
747-71-0069-113	65	68,5 - 72,0	69,0	40	0.5	170.95
747-71-0073-113	65	72,5 - 76,5	73,0	40	0.5	173.53
747-71-0076-113	65	75,0 - 79,0	76,1	40	0.6	176.17
747-71-0079-113	80	78,8 - 83,0	79,9	40	1.2	180.41
747-71-0084-113	80	82,5 - 86,0	84,0	40	1.3	183.11
747-71-0089-113	80	88,0 - 92,0	88,9	40	1.3	185.81
747-71-0101-113	100	100,0 - 104,0	101,6	33	1.3	193.78
747-71-0104-113	100	102,0 - 106,0	104,0	33	1.3	203.80
747-71-0106-113	100	105,0 - 108,5	106,3	33	1.3	206.90
747-71-0108-113	100	106,0 - 110,0	108,0	33	1.3	209.98
747-71-0114-113	100	113,0 - 118,0	114,3	33	1.3	213.13
747-71-0127-113	125	125,0 - 129,5	127,0	24	1.4	214.15
747-71-0129-113	125	127,5 - 131,0	129,0	24	1.4	217.37
747-71-0133-113	125	131,0 - 135,5	131,7	24	1.4	261.79
747-71-0139-113	125	138,0 - 142,5	139,7	24	1.4	265.77
747-71-0141-113	125	139,5 - 144,0	141,3	24	1.4	269.76
747-71-0154-113	150	151,5 - 156,0	154,0	24	1.5	278.17
747-71-0159-113	150	156,0 - 161,0	157,7	24	1.5	282.35
747-71-0165-113	150	164,0 - 168,5	165,2	24	1.5	286.60
747-71-0168-113	150	166,0 - 170,5	168,3	24	1.5	290.92
747-71-0180-113	175	178,0 - 183,0	180,0	21	1.5	301.37
747-71-0200-113	200	198,0 - 203,5	200,0	21	1.9	430.49
747-71-0204-113	200	202,0 - 206,5	204,0	21	2.0	436.98
747-71-0216-113	200	214,0 - 219,0	216,3	21	2.0	443.55
747-71-0219-113	200	216,5 - 222,0	219,1	21	2.0	450.16
747-71-0254-113	225	251,0 - 257,0	254,0	21	2.1	534.44
747-71-0267-113	250	262,0 - 270,0	267,4	21	2.2	641.38
747-71-0273-113	250	270,0 - 277,0	273,0	21	2.2	650.96
747-71-0304-113	275	301,5 - 309,0	304,0	17	2.3	654.24
747-71-0318-113	300	316,0 - 323,0	318,5	17	2.4	743.83
747-71-0323-113	300	322,0 - 329,0	323,9	17	2.4	754.94
747-71-0355-113	350	352,0 - 361,0	355,6	16	2.5	899.76
747-71-0406-113	400	402,0 - 411,0	406,4	14	2.7	997.71
747-71-0457-113	450	453,0 - 462,0	457,2	13	2.9	1,095.53
747-71-0508-113	500	504,0 - 513,0	508,0	12	3.1	1,189.24

747/71-114

Repico® RE
 Repair coupling for elbows
 For repair of elbows, bends or
 welds
 Stainless steel



AVK ref. no.	DN mm	Tolerance mm	Pipe dia. mm	Working Pressure bar	Theoretical weight/kg	Gross Price EUR
747-71-0015-114	15	15,3 - 17,0	15,5	53	0.2	167.95
747-71-0020-114	15	19,5 - 21,3	20,0	46	0.2	170.52
747-71-0021-114	15	21,0 - 23,0	21,3	46	0.2	173.02
747-71-0025-114	20	24,0 - 26,5	25,0	46	0.2	174.30
747-71-0027-114	20	26,0 - 28,5	26,7	46	0.2	176.94
747-71-0028-114	25	26,4 - 29,5	28,2	46	0.2	193.73
747-71-0030-114	25	29,0 - 31,5	30,0	46	0.2	194.67
747-71-0032-114	25	31,0 - 33,5	32,0	46	0.2	195.70
747-71-0034-114	25	33,0 - 35,5	33,4	46	0.2	196.68
747-71-0038-114	32	37,0 - 39,5	38,0	46	0.2	219.62
747-71-0040-114	32	39,5 - 41,8	40,0	46	0.2	222.96
747-71-0042-114	32	42,0 - 44,5	42,2	46	0.2	226.30
747-71-0044-114	32	44,0 - 46,5	44,5	40	0.2	229.65
747-71-0048-114	40	47,5 - 50,5	48,3	40	0.2	230.80
747-71-0050-114	50	49,2 - 51,5	50,8	40	0.2	318.72
747-71-0054-114	50	53,0 - 56,0	54,0	40	0.5	406.71
747-71-0057-114	50	56,0 - 59,0	57,0	40	0.5	408.71
747-71-0060-114	50	59,0 - 62,0	60,3	40	0.5	410.76
747-71-0063-114	50	62,0 - 65,0	63,0	40	0.5	412.81
747-71-0066-114	65	65,4 - 69,0	66,7	40	0.5	483.01
747-71-0069-114	65	68,5 - 72,0	69,0	40	0.5	490.21
747-71-0073-114	65	72,5 - 76,5	73,0	40	0.5	497.61
747-71-0076-114	65	75,0 - 79,0	76,1	40	0.6	505.05
747-71-0079-114	80	78,8 - 83,0	79,9	40	1.2	527.86
747-71-0084-114	80	82,5 - 86,0	84,0	40	1.3	535.78
747-71-0089-114	80	88,0 - 92,0	88,9	40	1.3	543.81
747-71-0101-114	100	100,0 - 104,0	101,6	33	1.3	618.11
747-71-0104-114	100	102,0 - 106,0	104,0	33	1.3	644.78
747-71-0106-114	100	105,0 - 108,5	106,3	33	1.3	654.49
747-71-0108-114	100	106,0 - 110,0	108,0	33	1.3	664.32
747-71-0114-114	100	113,0 - 118,0	114,3	33	1.3	674.29
747-71-0127-114	125	125,0 - 129,5	127,0	24	1.4	684.36
747-71-0129-114	125	127,5 - 131,0	129,0	24	1.4	694.66
747-71-0133-114	125	131,0 - 135,5	131,7	24	1.4	827.38
747-71-0139-114	125	138,0 - 142,5	139,7	24	1.4	839.78
747-71-0141-114	125	139,5 - 144,0	141,3	24	1.4	852.38
747-71-0154-114	150	151,5 - 156,0	154,0	24	1.5	861.13
747-71-0159-114	150	156,0 - 161,0	157,7	24	1.5	874.05
747-71-0165-114	150	164,0 - 168,5	165,2	24	1.5	887.17
747-71-0168-114	150	166,0 - 170,5	168,3	24	1.5	900.45
747-71-0180-114	175	178,0 - 183,0	180,0	21	1.5	932.85
747-71-0200-114	200	198,0 - 203,5	200,0	21	1.9	1,367.01
747-71-0204-114	200	202,0 - 206,5	204,0	21	2.0	1,387.52
747-71-0216-114	200	214,0 - 219,0	216,3	21	2.0	1,408.29
747-71-0219-114	200	216,5 - 222,0	219,1	21	2.0	1,429.41
747-71-0254-114	225	251,0 - 257,0	254,0	21	2.1	1,696.93
747-71-0267-114	250	262,0 - 270,0	267,4	21	2.2	1,897.40
747-71-0273-114	250	270,0 - 277,0	273,0	21	2.2	1,925.80
747-71-0304-114	275	301,5 - 309,0	304,0	17	2.3	1,935.46
747-71-0318-114	300	316,0 - 323,0	318,5	17	2.4	2,048.82
747-71-0323-114	300	322,0 - 329,0	323,9	17	2.4	2,079.60
747-71-0355-114	350	352,0 - 361,0	355,6	16	2.5	2,164.71
747-71-0406-114	400	402,0 - 411,0	406,4	14	2.7	2,325.01
747-71-0457-114	450	453,0 - 462,0	457,2	13	2.9	2,583.32
747-71-0508-114	500	504,0 - 513,0	508,0	12	3.1	2,846.13

747/81-111

Repico® RH
Hinge type repair coupling
For all pipe types
Stainless steel
EPDM drinking water
approved



AVK ref. no.	DN mm	Tolerance mm	Pipe dia. mm	Working Pressure bar	Theoretical weight/kg	Gross Price EUR
747-81-0020-111	15	19,5 - 20,5	20,0	42	0.3	135.61
747-81-0021-111	15	21,0 - 22,0	21,3	42	0.3	137.61
747-81-0025-111	20	24,0 - 26,0	25,0	42	0.4	161.52
747-81-0027-111	20	26,0 - 28,0	26,7	42	0.4	163.90
747-81-0028-111	25	26,4 - 29,0	28,2	42	0.4	167.95
747-81-0030-111	25	29,0 - 31,0	30,0	42	0.4	169.62
747-81-0032-111	25	31,0 - 33,0	32,0	42	0.4	171.35
747-81-0034-111	25	33,0 - 35,0	33,4	42	0.4	173.09
747-81-0038-111	32	37,0 - 39,0	38,0	42	0.4	174.46
747-81-0040-111	32	39,5 - 41,3	40,0	42	0.4	176.17
747-81-0042-111	32	42,0 - 44,0	42,2	42	0.4	177.97
747-81-0044-111	32	44,0 - 46,0	44,5	42	0.4	179.70
747-81-0048-111	40	47,5 - 49,5	48,3	42	0.5	180.94
747-81-0050-111	50	49,2 - 51,5	50,8	42	0.5	192.30
747-81-0054-111	50	53,0 - 55,0	54,0	42	0.7	194.23
747-81-0057-111	50	56,0 - 58,0	57,0	42	0.7	196.22
747-81-0060-111	50	59,0 - 61,5	60,3	42	0.7	197.19
747-81-0063-111	50	62,0 - 64,0	63,0	42	0.7	199.12
747-81-0066-111	65	65,4 - 68,3	66,7	37	0.8	207.80
747-81-0069-111	65	68,5 - 71,0	69,0	37	0.8	210.88
747-81-0073-111	65	72,5 - 75,5	73,0	37	0.8	214.03
747-81-0076-111	65	75,0 - 78,0	76,1	37	0.8	217.24
747-81-0079-111	80	78,8 - 82,0	79,9	37	1.6	218.34
747-81-0084-111	80	82,5 - 85,5	84,0	37	1.6	219.42
747-81-0089-111	80	88,0 - 91,0	88,9	37	1.6	219.54
747-81-0101-111	100	100,0 - 103,0	101,6	37	1.7	220.64
747-81-0104-111	100	102,0 - 105,0	104,0	37	1.7	230.75
747-81-0106-111	100	105,0 - 107,0	106,3	37	1.7	234.21
747-81-0108-111	100	106,0 - 109,0	108,0	37	1.7	237.75
747-81-0114-111	100	113,0 - 116,0	114,3	37	1.7	241.27
747-81-0127-111	125	125,0 - 129,0	127,0	37	2.1	286.33
747-81-0129-111	125	127,5 - 130,0	129,0	37	2.2	290.58
747-81-0133-111	125	131,0 - 135,0	131,7	37	2.2	294.93
747-81-0139-111	125	138,0 - 142,0	139,7	37	2.2	299.37
747-81-0141-111	125	139,5 - 143,0	141,3	37	2.3	303.88
747-81-0154-111	150	151,5 - 155,0	154,0	32	2.3	305.43
747-81-0159-111	150	156,0 - 160,0	157,7	32	2.4	305.88
747-81-0165-111	150	164,0 - 167,0	165,2	32	2.4	310.50
747-81-0168-111	150	166,0 - 170,0	168,3	32	2.4	315.14
747-81-0180-111	175	178,0 - 182,0	180,0	26	2.5	326.50
747-81-0200-111	200	198,0 - 203,0	200,0	21	5.0	584.89
747-81-0204-111	200	202,0 - 206,0	204,0	21	5.1	587.77
747-81-0216-111	200	214,0 - 218,0	216,3	21	5.2	590.73
747-81-0219-111	200	216,5 - 221,0	219,1	21	5.2	593.70
747-81-0254-111	225	251,0 - 257,0	254,0	21	5.6	797.30
747-81-0267-111	250	262,0 - 269,0	267,4	21	5.8	809.27
747-81-0273-111	250	270,0 - 276,0	273,0	21	5.8	821.40
747-81-0304-111	275	301,5 - 308,0	304,0	18	6.2	864.10
747-81-0318-111	300	316,0 - 322,0	318,5	18	6.4	877.07
747-81-0323-111	300	322,0 - 328,0	323,9	18	6.4	890.24
747-81-0355-111	350	352,0 - 360,0	355,6	18	6.8	966.53
747-81-0406-111	400	402,0 - 410,0	406,4	16	7.4	1,033.37
747-81-0457-111	450	453,0 - 460,0	457,2	16	8.0	1,104.66
747-81-0508-111	500	504,0 - 512,0	508,0	13	8.5	1,171.43
747-81-0558-111	550	555,0 - 563,0	558,8	12	9.1	1,247.09
747-81-0609-111	600	605,0 - 614,0	609,6	11	9.7	1,318.37

747/81-112

Repico® RH
Hinge type repair coupling
For all pipe types
Stainless steel
NBR rubber



AVK ref. no.	DN mm	Tolerance mm	Pipe dia. mm	Working Pressure bar	Theoretical weight/kg	Gross Price EUR
747-81-0020-112	15	19,5 - 20,5	20,0	42	0.3	135.61
747-81-0021-112	15	21,0 - 22,0	21,3	42	0.3	137.61
747-81-0025-112	20	24,0 - 26,0	25,0	42	0.4	161.52
747-81-0027-112	20	26,0 - 28,0	26,7	42	0.4	163.90
747-81-0028-112	25	26,4 - 29,0	28,2	42	0.4	167.95
747-81-0030-112	25	29,0 - 31,0	30,0	42	0.4	169.62
747-81-0032-112	25	31,0 - 33,0	32,0	42	0.4	171.35
747-81-0034-112	25	33,0 - 35,0	33,4	42	0.4	173.09
747-81-0038-112	32	37,0 - 39,0	38,0	42	0.4	174.46
747-81-0040-112	32	39,5 - 41,3	40,0	42	0.4	176.17
747-81-0042-112	32	42,0 - 44,0	42,2	42	0.4	177.97
747-81-0044-112	32	44,0 - 46,0	44,5	42	0.4	179.70
747-81-0048-112	40	47,5 - 49,5	48,3	42	0.5	180.94
747-81-0050-112	50	49,2 - 51,5	50,8	42	0.5	192.30
747-81-0054-112	50	53,0 - 55,0	54,0	42	0.7	194.23
747-81-0057-112	50	56,0 - 58,0	57,0	42	0.7	196.22
747-81-0060-112	50	59,0 - 61,5	60,3	42	0.7	197.19
747-81-0063-112	50	62,0 - 64,0	63,0	42	0.7	199.12
747-81-0066-112	65	65,4 - 68,3	66,7	37	0.8	207.80
747-81-0069-112	65	68,5 - 71,0	69,0	37	0.8	210.88
747-81-0073-112	65	72,5 - 75,5	73,0	37	0.8	214.03
747-81-0076-112	65	75,0 - 78,0	76,1	37	0.8	217.24
747-81-0079-112	80	78,8 - 82,0	79,9	37	1.6	218.34
747-81-0084-112	80	82,5 - 85,5	84,0	37	1.6	219.42
747-81-0089-112	80	88,0 - 91,0	88,9	37	1.6	219.54
747-81-0101-112	100	100,0 - 103,0	101,6	37	1.7	220.64
747-81-0104-112	100	102,0 - 105,0	104,0	37	1.7	230.75
747-81-0106-112	100	105,0 - 107,0	106,3	37	1.7	234.21
747-81-0108-112	100	106,0 - 109,0	108,0	37	1.7	237.75
747-81-0114-112	100	113,0 - 116,0	114,3	37	1.7	241.27
747-81-0127-112	125	125,0 - 129,0	127,0	37	2.1	286.33
747-81-0129-112	125	127,5 - 130,0	129,0	37	2.2	290.58
747-81-0133-112	125	131,0 - 135,0	131,7	37	2.2	294.93
747-81-0139-112	125	138,0 - 142,0	139,7	37	2.2	299.37
747-81-0141-112	125	139,5 - 143,0	141,3	37	2.3	303.88
747-81-0154-112	150	151,5 - 155,0	154,0	32	2.3	305.43
747-81-0159-112	150	156,0 - 160,0	157,7	32	2.4	305.88
747-81-0165-112	150	164,0 - 167,0	165,2	32	2.4	310.50
747-81-0168-112	150	166,0 - 170,0	168,3	32	2.4	315.14
747-81-0180-112	175	178,0 - 182,0	180,0	26	2.5	326.50
747-81-0200-112	200	198,0 - 203,0	200,0	21	5.0	584.89
747-81-0204-112	200	202,0 - 206,0	204,0	21	5.1	587.77
747-81-0216-112	200	214,0 - 218,0	216,3	21	5.2	590.73
747-81-0219-112	200	216,5 - 221,0	219,1	21	5.2	593.70
747-81-0254-112	225	251,0 - 257,0	254,0	21	5.6	797.30
747-81-0267-112	250	262,0 - 269,0	267,4	21	5.8	809.27
747-81-0273-112	250	270,0 - 276,0	273,0	21	5.8	821.40
747-81-0304-112	275	301,5 - 308,0	304,0	18	6.2	864.10
747-81-0318-112	300	316,0 - 322,0	318,5	18	6.4	877.07
747-81-0323-112	300	322,0 - 328,0	323,9	18	6.4	890.24
747-81-0355-112	350	352,0 - 360,0	355,6	18	6.8	966.53
747-81-0406-112	400	402,0 - 410,0	406,4	16	7.4	1,033.37
747-81-0457-112	450	453,0 - 460,0	457,2	16	8.0	1,104.66
747-81-0508-112	500	504,0 - 512,0	508,0	13	8.5	1,171.43
747-81-0558-112	550	555,0 - 563,0	558,8	12	9.1	1,247.09
747-81-0609-112	600	605,0 - 614,0	609,6	11	9.7	1,318.37

747/81-113

Repico® RH
Hinge type repair coupling
For all pipe types
Stainless steel
Silicone rubber



AVK ref. no.	DN mm	Tolerance mm	Pipe dia. mm	Working Pressure bar	Theoretical weight/kg	Gross Price EUR
747-81-0020-113	15	19,5 - 20,5	20,0	42	0.3	155.02
747-81-0021-113	15	21,0 - 22,0	21,3	42	0.3	157.34
747-81-0025-113	20	24,0 - 26,0	25,0	42	0.4	180.80
747-81-0027-113	20	26,0 - 28,0	26,7	42	0.4	183.50
747-81-0028-113	25	26,4 - 29,0	28,2	42	0.4	187.29
747-81-0030-113	25	29,0 - 31,0	30,0	42	0.4	189.15
747-81-0032-113	25	31,0 - 33,0	32,0	42	0.4	191.01
747-81-0034-113	25	33,0 - 35,0	33,4	42	0.4	192.96
747-81-0038-113	32	37,0 - 39,0	38,0	42	0.4	200.21
747-81-0040-113	32	39,5 - 41,3	40,0	42	0.4	202.20
747-81-0042-113	32	42,0 - 44,0	42,2	42	0.4	204.26
747-81-0044-113	32	44,0 - 46,0	44,5	42	0.4	206.26
747-81-0048-113	40	47,5 - 49,5	48,3	42	0.5	206.82
747-81-0050-113	50	49,2 - 51,5	50,8	42	0.5	224.31
747-81-0054-113	50	53,0 - 55,0	54,0	42	0.7	241.81
747-81-0057-113	50	56,0 - 58,0	57,0	42	0.7	244.24
747-81-0060-113	50	59,0 - 61,5	60,3	42	0.7	245.47
747-81-0063-113	50	62,0 - 64,0	63,0	42	0.7	247.90
747-81-0066-113	65	65,4 - 68,3	66,7	37	0.8	269.63
747-81-0069-113	65	68,5 - 71,0	69,0	37	0.8	273.61
747-81-0073-113	65	72,5 - 75,5	73,0	37	0.8	277.71
747-81-0076-113	65	75,0 - 78,0	76,1	37	0.8	281.90
747-81-0079-113	80	78,8 - 82,0	79,9	37	1.6	286.14
747-81-0084-113	80	82,5 - 85,5	84,0	37	1.6	288.97
747-81-0089-113	80	88,0 - 91,0	88,9	37	1.6	291.86
747-81-0101-113	100	100,0 - 103,0	101,6	37	1.7	296.30
747-81-0104-113	100	102,0 - 105,0	104,0	37	1.7	300.72
747-81-0106-113	100	105,0 - 107,0	106,3	37	1.7	305.23
747-81-0108-113	100	106,0 - 109,0	108,0	37	1.7	309.81
747-81-0114-113	100	113,0 - 116,0	114,3	37	1.7	314.42
747-81-0127-113	125	125,0 - 129,0	127,0	37	2.1	319.19
747-81-0129-113	125	127,5 - 130,0	129,0	37	2.2	323.93
747-81-0133-113	125	131,0 - 135,0	131,7	37	2.2	363.00
747-81-0139-113	125	138,0 - 142,0	139,7	37	2.2	368.48
747-81-0141-113	125	139,5 - 143,0	141,3	37	2.3	374.00
747-81-0154-113	150	151,5 - 155,0	154,0	32	2.3	380.89
747-81-0159-113	150	156,0 - 160,0	157,7	32	2.4	386.61
747-81-0165-113	150	164,0 - 167,0	165,2	32	2.4	392.39
747-81-0168-113	150	166,0 - 170,0	168,3	32	2.4	398.29
747-81-0180-113	175	178,0 - 182,0	180,0	26	2.5	412.63
747-81-0200-113	200	198,0 - 203,0	200,0	21	5.0	771.40
747-81-0204-113	200	202,0 - 206,0	204,0	21	5.1	775.25
747-81-0216-113	200	214,0 - 218,0	216,3	21	5.2	779.17
747-81-0219-113	200	216,5 - 221,0	219,1	21	5.2	783.04
747-81-0254-113	225	251,0 - 257,0	254,0	21	5.6	957.60
747-81-0267-113	250	262,0 - 269,0	267,4	21	5.8	1,037.81
747-81-0273-113	250	270,0 - 276,0	273,0	21	5.8	1,053.36
747-81-0304-113	275	301,5 - 308,0	304,0	18	6.2	1,069.18
747-81-0318-113	300	316,0 - 322,0	318,5	18	6.4	1,117.08
747-81-0323-113	300	322,0 - 328,0	323,9	18	6.4	1,133.82
747-81-0355-113	350	352,0 - 360,0	355,6	18	6.8	1,251.53
747-81-0406-113	400	402,0 - 410,0	406,4	16	7.4	1,389.64
747-81-0457-113	450	453,0 - 460,0	457,2	16	8.0	1,505.47
747-81-0508-113	500	504,0 - 512,0	508,0	13	8.5	1,616.86
747-81-0558-113	550	555,0 - 563,0	558,8	12	9.1	1,728.10
747-81-0609-113	600	605,0 - 614,0	609,6	11	9.7	1,843.99

747/81-114

Repico® RH
Hinge type repair coupling
For all pipe types
Stainless steel



AVK ref. no.	DN mm	Tolerance mm	Pipe dia. mm	Working Pressure bar	Theoretical weight/kg	Gross Price EUR
747-81-0020-114	15	19,5 - 20,5	20,0	42	0.3	258.38
747-81-0021-114	15	21,0 - 22,0	21,3	42	0.3	262.23
747-81-0025-114	20	24,0 - 26,0	25,0	42	0.4	290.58
747-81-0027-114	20	26,0 - 28,0	26,7	42	0.4	294.93
747-81-0028-114	25	26,4 - 29,0	28,2	42	0.4	316.49
747-81-0030-114	25	29,0 - 31,0	30,0	42	0.4	319.70
747-81-0032-114	25	31,0 - 33,0	32,0	42	0.4	322.84
747-81-0034-114	25	33,0 - 35,0	33,4	42	0.4	326.11
747-81-0038-114	32	37,0 - 39,0	38,0	42	0.4	342.26
747-81-0040-114	32	39,5 - 41,3	40,0	42	0.4	345.72
747-81-0042-114	32	42,0 - 44,0	42,2	42	0.4	349.13
747-81-0044-114	32	44,0 - 46,0	44,5	42	0.4	352.67
747-81-0048-114	40	47,5 - 49,5	48,3	42	0.5	361.73
747-81-0050-114	50	49,2 - 51,5	50,8	42	0.5	439.18
747-81-0054-114	50	53,0 - 55,0	54,0	42	0.7	516.68
747-81-0057-114	50	56,0 - 58,0	57,0	42	0.7	521.83
747-81-0060-114	50	59,0 - 61,5	60,3	42	0.7	527.10
747-81-0063-114	50	62,0 - 64,0	63,0	42	0.7	532.36
747-81-0066-114	65	65,4 - 68,3	66,7	37	0.8	606.54
747-81-0069-114	65	68,5 - 71,0	69,0	37	0.8	615.62
747-81-0073-114	65	72,5 - 75,5	73,0	37	0.8	624.86
747-81-0076-114	65	75,0 - 78,0	76,1	37	0.8	634.24
747-81-0079-114	80	78,8 - 82,0	79,9	37	1.6	684.88
747-81-0084-114	80	82,5 - 85,5	84,0	37	1.6	691.77
747-81-0089-114	80	88,0 - 91,0	88,9	37	1.6	698.65
747-81-0101-114	100	100,0 - 103,0	101,6	37	1.7	745.12
747-81-0104-114	100	102,0 - 105,0	104,0	37	1.7	828.60
747-81-0106-114	100	105,0 - 107,0	106,3	37	1.7	840.99
747-81-0108-114	100	106,0 - 109,0	108,0	37	1.7	853.60
747-81-0114-114	100	113,0 - 116,0	114,3	37	1.7	866.46
747-81-0127-114	125	125,0 - 129,0	127,0	37	2.1	879.45
747-81-0129-114	125	127,5 - 130,0	129,0	37	2.2	892.62
747-81-0133-114	125	131,0 - 135,0	131,7	37	2.2	1,057.74
747-81-0139-114	125	138,0 - 142,0	139,7	37	2.2	1,073.62
747-81-0141-114	125	139,5 - 143,0	141,3	37	2.3	1,089.69
747-81-0154-114	150	151,5 - 155,0	154,0	32	2.3	1,188.98
747-81-0159-114	150	156,0 - 160,0	157,7	32	2.4	1,206.85
747-81-0165-114	150	164,0 - 167,0	165,2	32	2.4	1,224.91
747-81-0168-114	150	166,0 - 170,0	168,3	32	2.4	1,243.29
747-81-0180-114	175	178,0 - 182,0	180,0	26	2.5	1,288.08
747-81-0200-114	200	198,0 - 203,0	200,0	21	5.0	2,152.83
747-81-0204-114	200	202,0 - 206,0	204,0	21	5.1	2,163.56
747-81-0216-114	200	214,0 - 218,0	216,3	21	5.2	2,174.35
747-81-0219-114	200	216,5 - 221,0	219,1	21	5.2	2,185.28
747-81-0254-114	225	251,0 - 257,0	254,0	21	5.6	2,672.45
747-81-0267-114	250	262,0 - 269,0	267,4	21	5.8	3,108.93
747-81-0273-114	250	270,0 - 276,0	273,0	21	5.8	3,155.53
747-81-0304-114	275	301,5 - 308,0	304,0	18	6.2	3,171.35
747-81-0318-114	300	316,0 - 322,0	318,5	18	6.4	3,549.85
747-81-0323-114	300	322,0 - 328,0	323,9	18	6.4	3,603.06
747-81-0355-114	350	352,0 - 360,0	355,6	18	6.8	4,213.54
747-81-0406-114	400	402,0 - 410,0	406,4	16	7.4	4,854.91
747-81-0457-114	450	453,0 - 460,0	457,2	16	8.0	5,398.28
747-81-0508-114	500	504,0 - 512,0	508,0	13	8.5	5,928.26
747-81-0558-114	550	555,0 - 563,0	558,8	12	9.1	6,467.19
747-81-0609-114	600	605,0 - 614,0	609,6	11	9.7	7,023.99

747/82-111

Repico® RHL
Hinge type repair coupling
long version
For all pipe types
Stainless steel
EPDM drinking water
approved



AVK ref. no.	DN mm	Tolerance mm	Pipe dia. mm	Working Pressure bar	Theoretical weight/kg	Gross Price EUR
747-82-0032-111	25	31,0 - 33,0	32,0	42	0.6	214.09
747-82-0034-111	25	33,0 - 35,0	33,4	42	0.6	217.31
747-82-0042-111	32	42,0 - 44,0	42,2	42	0.7	229.38
747-82-0048-111	40	47,5 - 49,5	48,3	42	0.7	232.80
747-82-0050-111	50	49,2 - 51,5	50,8	42	0.7	313.32
747-82-0060-111	50	59,0 - 61,5	60,3	42	1.3	318.02
747-82-0063-111	50	62,0 - 64,0	63,0	42	1.4	322.84
747-82-0069-111	65	68,5 - 71,0	69,0	37	1.4	342.58
747-82-0073-111	65	72,5 - 75,5	73,0	37	1.4	347.71
747-82-0076-111	65	75,0 - 78,0	76,1	37	1.5	352.93
747-82-0079-111	80	78,8 - 82,0	79,9	37	2.7	354.66
747-82-0089-111	80	88,0 - 91,0	88,9	37	2.8	356.46
747-82-0098-111	100	96,0 - 99,0	98,0	37	2.8	357.75
747-82-0101-111	100	100,0 - 103,0	101,6	37	2.9	358.26
747-82-0104-111	100	102,0 - 105,0	104,0	37	2.9	367.51
747-82-0106-111	100	105,0 - 107,0	106,3	37	3.0	373.04
747-82-0108-111	100	106,0 - 109,0	108,0	37	3.0	378.64
747-82-0114-111	100	113,0 - 116,0	114,3	37	3.0	384.35
747-82-0118-111	100	116,0 - 119,0	118,0	37	3.2	388.03
747-82-0139-111	125	138,0 - 142,0	139,7	37	4.0	478.25
747-82-0141-111	125	139,5 - 143,0	141,3	37	4.0	485.45
747-82-0159-111	150	156,0 - 160,0	157,7	32	4.2	493.49
747-82-0165-111	150	164,0 - 167,0	165,2	32	4.3	500.95
747-82-0168-111	150	166,0 - 170,0	168,3	32	4.3	508.40
747-82-0216-111	200	214,0 - 218,0	216,3	21	9.9	1,036.91
747-82-0219-111	200	216,5 - 221,0	219,1	21	10.0	1,052.47
747-82-0267-111	250	262,0 - 269,0	267,4	21	11	1,385.14
747-82-0273-111	250	270,0 - 276,0	273,0	21	11	1,405.96
747-82-0318-111	300	316,0 - 322,0	318,5	18	12	1,483.23
747-82-0323-111	300	322,0 - 328,0	323,9	18	12	1,505.47

747/82-112

Repico® RHL
Hinge type repair coupling
long version
For all pipe types
Stainless steel
NBR rubber



AVK ref. no.	DN mm	Tolerance mm	Pipe dia. mm	Working Pressure bar	Theoretical weight/kg	Gross Price EUR
747-82-0032-112	25	31,0 - 33,0	32,0	42	0.6	214.09
747-82-0034-112	25	33,0 - 35,0	33,4	42	0.6	217.31
747-82-0038-112		37 - 39	38	32	-	222.80
747-82-0042-112	32	42,0 - 44,0	42,2	42	0.7	229.38
747-82-0048-112	40	47,5 - 49,5	48,3	42	0.7	232.80
747-82-0050-112	50	49,2 - 51,5	50,8	42	0.7	313.32
747-82-0060-112	50	59,0 - 61,5	60,3	42	1.3	318.02
747-82-0063-112	50	62,0 - 64,0	63,0	42	1.4	322.84
747-82-0069-112	65	68,5 - 71,0	69,0	37	1.4	342.58
747-82-0073-112	65	72,5 - 75,5	73,0	37	1.4	347.71
747-82-0076-112	65	75,0 - 78,0	76,1	37	1.5	352.93
747-82-0079-112	80	78,8 - 82,0	79,9	37	2.7	354.66
747-82-0089-112	80	88,0 - 91,0	88,9	37	2.8	356.46
747-82-0101-112	100	100,0 - 103,0	101,6	37	2.9	358.26
747-82-0104-112	100	102,0 - 105,0	104,0	37	2.9	367.51
747-82-0106-112	100	105,0 - 107,0	106,3	37	3.0	373.04
747-82-0108-112	100	106,0 - 109,0	108,0	37	3.0	378.64
747-82-0114-112	100	113,0 - 116,0	114,3	37	3.0	384.35
747-82-0139-112	125	138,0 - 142,0	139,7	37	4.0	478.25
747-82-0141-112	125	139,5 - 143,0	141,3	37	4.0	485.45
747-82-0159-112	150	156,0 - 160,0	157,7	32	4.2	493.49
747-82-0165-112	150	164,0 - 167,0	165,2	32	4.3	500.95
747-82-0168-112	150	166,0 - 170,0	168,3	32	4.3	508.40
747-82-0216-112	200	214,0 - 218,0	216,3	21	9.9	1,036.91
747-82-0219-112	200	216,5 - 221,0	219,1	21	10.0	1,052.47
747-82-0267-112	250	262,0 - 269,0	267,4	21	11	1,385.14
747-82-0273-112	250	270,0 - 276,0	273,0	21	11	1,405.96
747-82-0318-112	300	316,0 - 322,0	318,5	18	12	1,483.23
747-82-0323-112	300	322,0 - 328,0	323,9	18	12	1,505.47

747/82-113

Repico® RHL
 Hinge type repair coupling
 long version
 For all pipe types
 Stainless steel
 Silicone rubber



AVK ref. no.	DN mm	Tolerance mm	Pipe dia. mm	Working Pressure bar	Theoretical weight/kg	Gross Price EUR
747-82-0032-113	25	31,0 - 33,0	32,0	42	0.6	238.97
747-82-0034-113	25	33,0 - 35,0	33,4	42	0.6	242.50
747-82-0042-113	32	42,0 - 44,0	42,2	42	0.7	249.13
747-82-0048-113	40	47,5 - 49,5	48,3	42	0.7	252.85
747-82-0050-113	50	49,2 - 51,5	50,8	42	0.7	256.64
747-82-0060-113	50	59,0 - 61,5	60,3	42	1.3	423.24
747-82-0063-113	50	62,0 - 64,0	63,0	42	1.4	429.60
747-82-0069-113	65	68,5 - 71,0	69,0	37	1.4	471.77
747-82-0073-113	65	72,5 - 75,5	73,0	37	1.4	474.07
747-82-0076-113	65	75,0 - 78,0	76,1	37	1.5	476.45
747-82-0079-113	80	78,8 - 82,0	79,9	37	2.7	478.85
747-82-0089-113	80	88,0 - 91,0	88,9	37	2.8	481.21
747-82-0101-113	100	100,0 - 103,0	101,6	37	2.9	483.65
747-82-0104-113	100	102,0 - 105,0	104,0	37	2.9	487.77
747-82-0106-113	100	105,0 - 107,0	106,3	37	3.0	495.10
747-82-0108-113	100	106,0 - 109,0	108,0	37	3.0	502.57
747-82-0114-113	100	113,0 - 116,0	114,3	37	3.0	510.07
747-82-0139-113	125	138,0 - 142,0	139,7	37	4.0	638.87
747-82-0141-113	125	139,5 - 143,0	141,3	37	4.0	648.45
747-82-0159-113	150	156,0 - 160,0	157,7	32	4.2	662.40
747-82-0165-113	150	164,0 - 167,0	165,2	32	4.3	672.36
747-82-0168-113	150	166,0 - 170,0	168,3	32	4.3	682.45
747-82-0216-113	200	214,0 - 218,0	216,3	21	9.9	1,338.28
747-82-0219-113	200	216,5 - 221,0	219,1	21	10.0	1,358.35
747-82-0267-113	250	262,0 - 269,0	267,4	21	11	1,803.87
747-82-0273-113	250	270,0 - 276,0	273,0	21	11	1,830.95
747-82-0318-113	300	316,0 - 322,0	318,5	18	12	1,941.94
747-82-0323-113	300	322,0 - 328,0	323,9	18	12	1,971.04

WITH AVK REPICO®

AVK REWAG ANSWERS TO ALL 8 AVK PROMISES

1. Expect solutions, not just products

- Besides our standard products we keep on providing innovative products that will help our customers

2. Expect global leadership and local commitment

- The AVK global product and manufacturing standards are used to ensure the AVK's full compliance to the renowned quality standards
- The local sales offices are committed to offer the best service possible

3. Expect quality in every step

- Our quality is not limited to the product itself. It concerns the entire process from the early specification to after-sales.
- Quality is not the result of a single link in the chain – it is the sum of all steps

4. Expect prompt response

- A vast stock is available to answer to our customer needs
- Our state of the art production facility enables us to supply non stocked items with the shortest possible delivery times

5. Expect lasting innovation

- Standard stainless steel 316 material

6. Expect total savings

- Being able to offer an extended range reduces the need of suppliers
- Offer top quality against competitive pricing

7. Expect a long-term partnership

- AVK REWAG has a tradition of long lasting relation with its customers and aims for long lasting partnerships through being a trustworthy partner

8. Expect it to be effective and easy

- We keep communication lines short
- Your local representative has direct communication with the factory

EXPECT MORE

Project package

- Your local AVK REWAG contact will be available to perform an onsite survey of your project and discuss the best possible solutions. If required a factory representative will support him.
- A full range of accessories can be offered to fulfill the project needs.
- Project specific testing and shop inspection can be offered.

Full package

- Next to our AVK promises we also offer the complete AVK product range, which enables our customer to benefit from more quality products.
- With most of its product ranges AVK is market leader, we expect that the Repico® product range will become no exception to this rule.



Repico®

1. Repico® types

Repico® G

Repico® S

Repico® St



Grip

Slip

Slip-Grip

2. Installation conditions

2.1 Check label

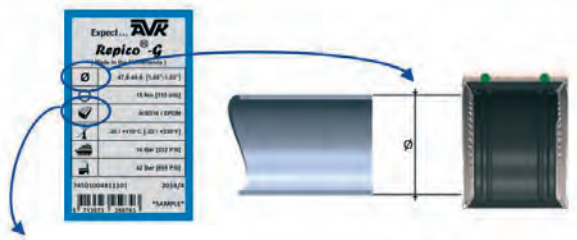

Check pressure

Gasket	
EPDM	-30 °C ↔ +110
NBR	-25 °C ↔ + 80
Silicone	-70 °C ↔ +200
Viton	-30 °C ↔ +250

2.2 Maximum gap

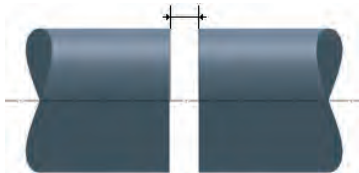

C _{max}	
DN15 ↔ DN _i	0 ↔ 8mm
>DN80	0 ↔ 15mm

2.3 Angular deflection

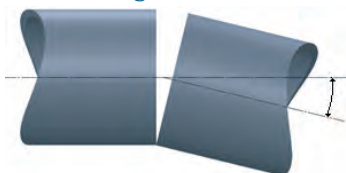

α _{max}	
DN15 ↔ DN _i	5°
DN65 ↔ DN _i	4°
>DN200	2°

2.4 Diameter

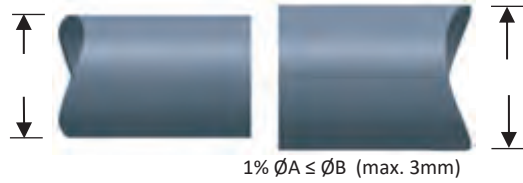

2.5 Misalignment

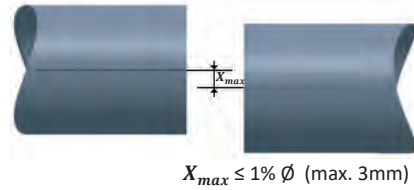

2.6 Ovality

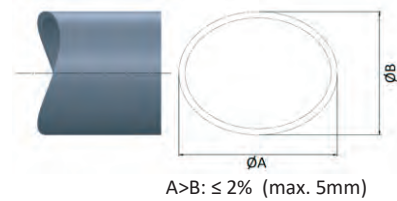

3. Preparations

3.1 Loosen bolts



3.2 Mark pipe

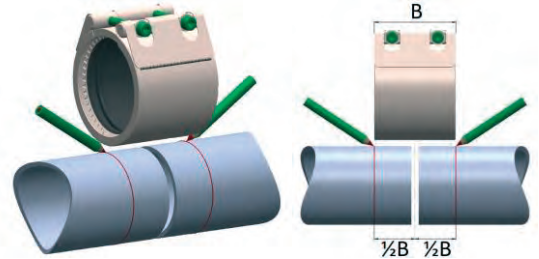

3.3 Clean pipe

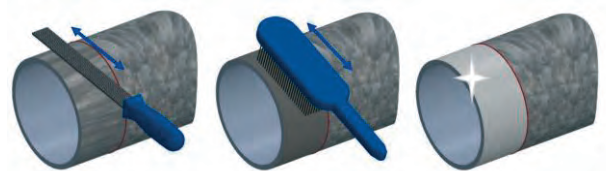

3.4 Insert - PE pipe





AVK REPICO® pipe coupling

Mounting instructions

Series 745

4. Assembly

4.1 Slide

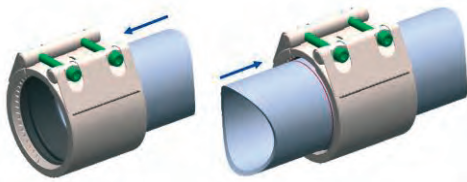

4.2 Tighten partial

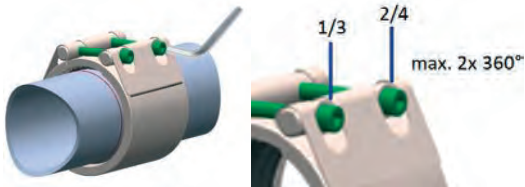

4.3 No rotating

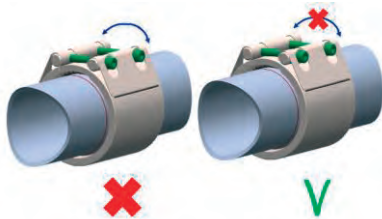

4.4 Apply torque

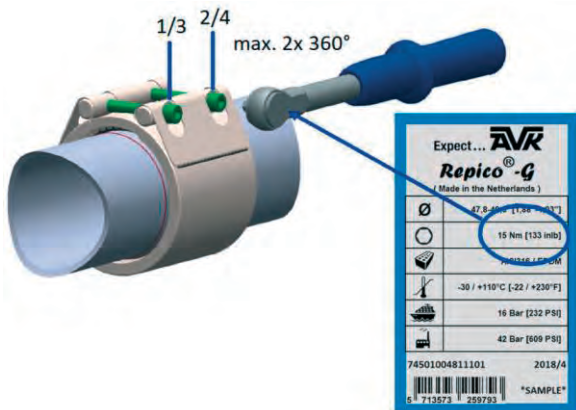

Expect... AVR
Repico®-G
(Made in the Netherlands)
Ø 47.8 mm (1.88" - 1.87")
15 Nm (133 inlb)
Pressure (PSI)
-30 / +110°C [-22 / +230°F]
16 Bar (232 PSI)
42 Bar (609 PSI)
74501004811101 2018/4
6 713873 255793 *SAMPLE*

4.5 Leakage control (look and smell)

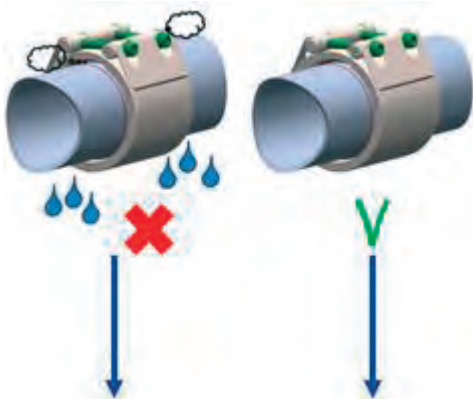

	Dissasse
	Prepara
	Assembl

Done ✓

5. Disassembly

5.1 Unpressurized

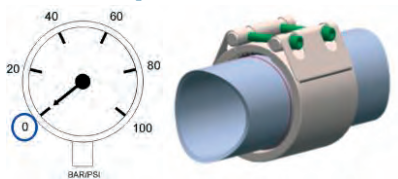

5.2 Careful - leakage



5.3 Support pipe

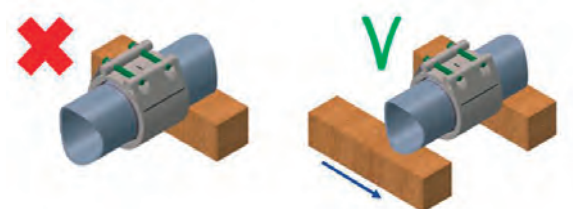

5.4 Loosen bolts



5.5 Slide, no rotating

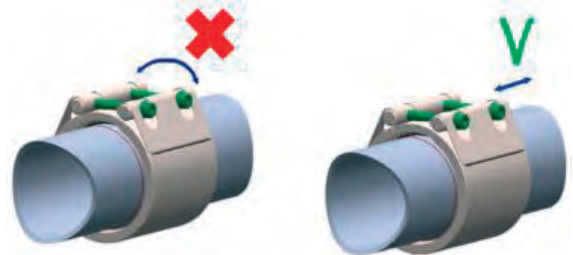

5.6 Removal

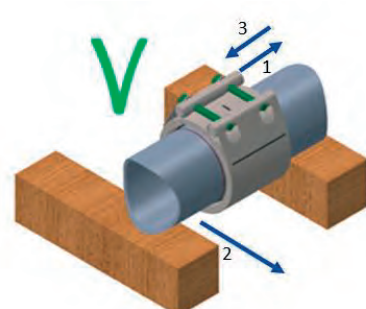



Repico®

1. Repico® types

Repico® RH



Repair Hinge

Repico® RSD

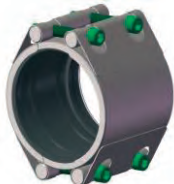

Repair Double

2. Installation conditions

2.1 Check label

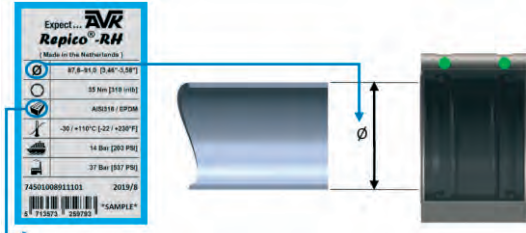

Check pressure rat

Gasket	
EPDM	-30 °C ↔ +110 °
NBR	-25 °C ↔ + 80 °
Silicone	-70 °C ↔ +200 °
Viton	-30 °C ↔ +250 °

2.2 Ovality

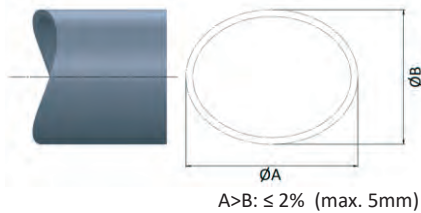

2.3 Damaged part

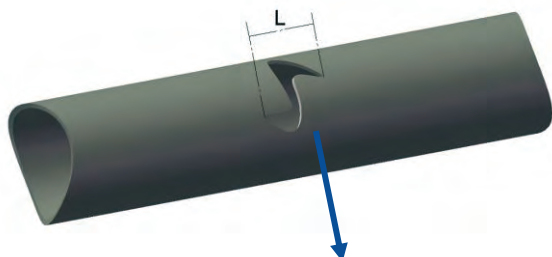

ND	L (Standard)		L (Long)	
	Dam	Clai	Dam	Clai
DN15-DN	28r	60n	70r	100i
DN50-DNi	44r	80n	110r	150i
DN80-DN	59r	110i	150r	200i
>DN200	89r	150i	185r	250i

3. Preparations

3.1 Mark pipe

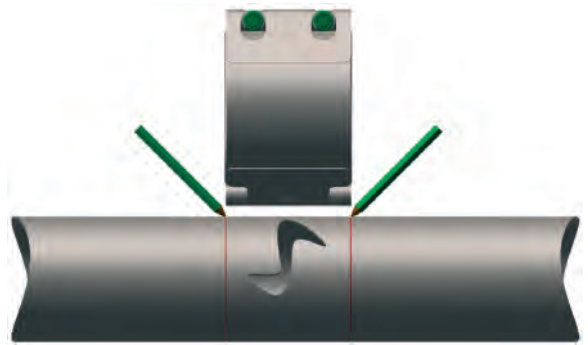
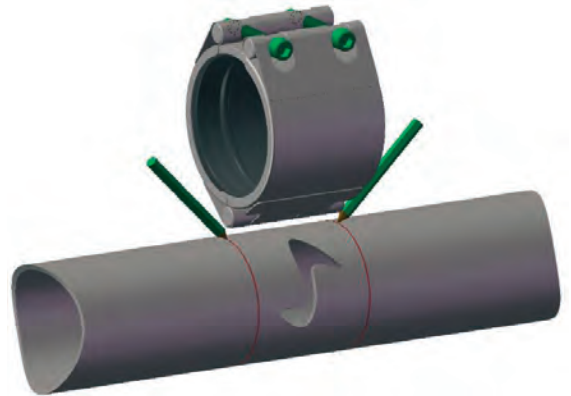

3.2 Clean pipe

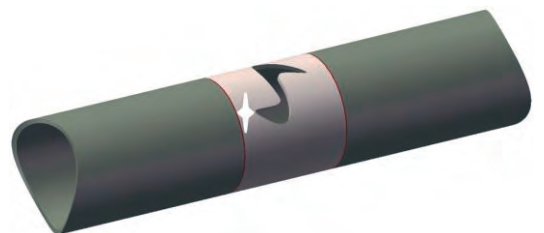
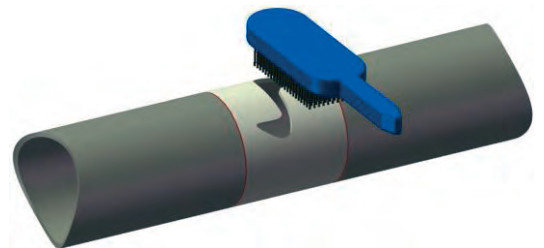
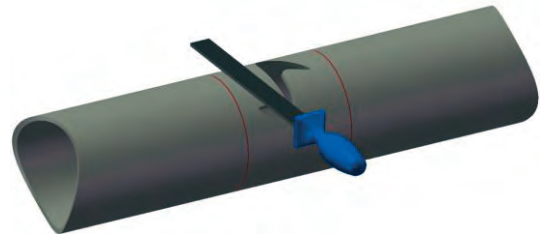



4. Assembly

4.1 Loosen bolts



4.2 Open clamp

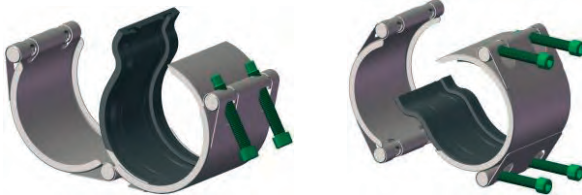

4.3 Mount clamp

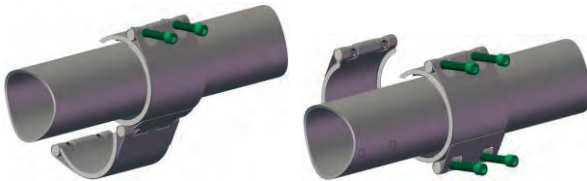

4.4 Close clamp

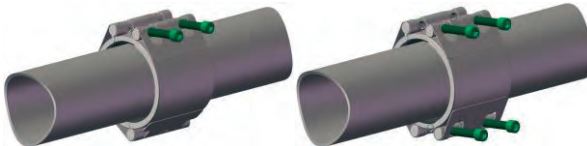

4.5 Tighten partial

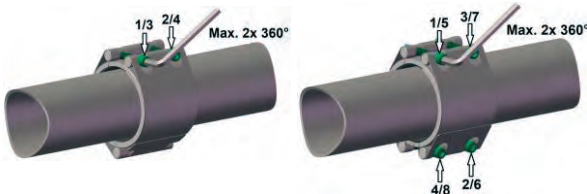

4.6 Apply torque

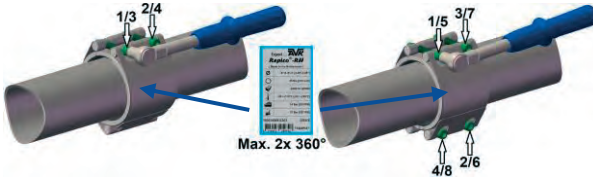

4.7 Leakage control (look and smell)



	Dissassen
	Preparati
	Assembly

Done

5. Disassembly

5.1 Unpressurized

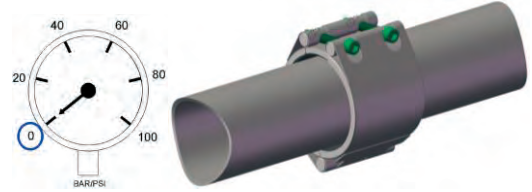

5.2 Careful - leakage



5.3 Loosen bolts

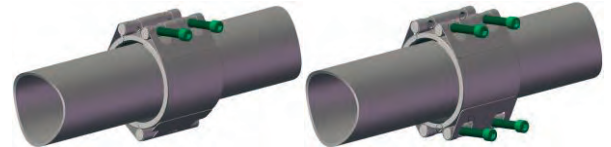

5.4 Open clamp

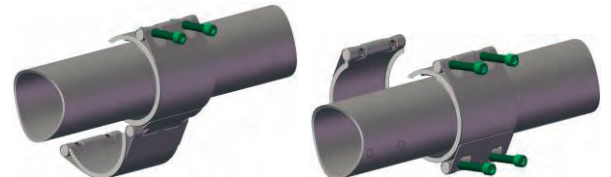

5.5 Reassemble for re-use



TERMS AND CONDITIONS OF SALE AND DELIVERY

§1 Offers and orders:

Offers from AVK Nederland BV (AVK) shall be subject to confirmation unless a written acceptance has been given to the contrary. Orders shall only be binding on us if at the receipt of a final, specified order we have the product at our disposal or can provide this at the prices and on the conditions with which we have calculated and on which we have based the offer - even though the purchaser may not be cognizant of such conditions. Moreover, the order shall be confirmed in writing by AVK.

§2 Terms of payment:

Unless otherwise agreed in writing AVK' terms of payment shall be as follows: Invoice date + 30 days net. Interest at a rate of 1,25% per commenced month will be charged on all overdue invoices. Interest will be added monthly. AVK will charge a fee of Euro 30 per payment reminder in case of overdue invoices.

§3 Prices:

The price of the products shall be AVK quoted price or, where no price has been quoted (or the quoted price is no longer valid) the price listed in AVK's published pricelist current at the date of acceptance of the order.

AVK reserves the right by giving notice to the buyer at any time before dispatch to increase the price of the products to reflect any increase in the cost to AVK which is due to factor beyond the control of AVK (such as, without limitations, any foreign exchange fluctuation, currency regulation, alteration of duties, significant increase in cost of labour, materials or other cost of manufacture) any change in delivery data, quantities or specifications for the products which is requested by the buyer, or any delay caused by any instruction of the buyer or failure of the buyer to give AVK adequate information or instructions.

The prices are exclusive of any import duties, VAT, levies, taxes and other charges which may be imposed on the goods.

§4 Delivery and transport:

All times of delivery shall as far as possible be in accordance with the customer's desires. The times of delivery have been fixed to the best of

our judgement, but AVK undertakes no obligations as regards a punctual observance of the time of delivery confirmed or desired.

Delivery will be effected ex works (EXW) unless otherwise agreed in writing.

AVK can at the customer's request arrange the transportation at the customer's expense and risk to any destination which can be reached by rail, sea, road or air.

§5 Cancellation and return:

An order can only be cancelled by written agreement between AVK and the customer. Moreover, AVK reserves the right to debit the customer with all costs which AVK may incur owing to the customer's wish to cancel the order. Returns cannot be allowed later than 3 months after delivery.

The customer cannot expect to be credited for more than 70% of the value debited. All returns shall show the original invoice number and date of delivery.

No return shall ever be allowed of special products, products which have been specially manufactured for the customer in question or products in which any specifications have been changed. The return of products to AVK shall be at the customer's expense and risk.

§6 Packaging:

The packaging is not returnable if it was included in the price, specially produced for the product supplied, or if it is disposable.

Packaging which was debited separately may only be returned upon previous agreement and no later than 3 months after the time of delivery.

§7 Liability for defects:

Only documented defects in the design, workmanship or material of the product supplied or faulty performance of work shall be considered defects.

The purchaser shall immediately after delivery carry out a reasonable examination of the product. The purchaser cannot adduce defects which could

have been established at such an examination unless the purchaser proves that AVK has received a written complaint no later than 8 days after delivery was effected.

The purchaser cannot adduce defects which could not have been established at an examination as the one mentioned above unless AVK has received a written complaint within 1 year after delivery was effected.

The purchaser shall have no other rights in connection with defects than a claim for a rectification of the defects as soon as possible in the form of repair, replacement delivery or subsequent delivery. A replacement delivery by AVK shall be conditional upon the purchaser returning the defective parts.

AVK shall in no case be liable for any trading loss, loss of time, loss of profit or any similar consequential losses owing to the defects.

§8 Product liability:

AVK shall not be liable for any pollution of or through air, ground or water and for any damage caused to things being used for purposes of trade.

AVK shall not be liable for damage to any real or personal property occurring while the product sold is in the purchaser's possession.

Nor shall AVK be liable for any damage to products produced by the purchaser or to products in which the product sold forms part, including real property, or to products for the production, treatment or processing of which the product is used. AVK shall not be liable for any damage to things in cases where the product sold is used for, built into or forms part of another finished product which is used for the operation of an aircraft or in off-shore installations.

Moreover, AVK' liability for any damage to real or personal property cannot exceed Euro 130,000 for each cause of damage for which AVK can be held liable.

AVK shall not be liable for any trading loss, loss of time, loss of profit, lost earnings or any other consequential losses.

To the extent that any product liability may be imposed on AVK towards any third party, the purchaser shall be liable to indemnify AVK to the same extent as AVK' liability is limited according to the above. However, these limitations in AVK' liability shall not apply if the damage can be ascribed as a gross negligence to a person for which AVK is responsible.

If a third party should advance claims against AVK or the purchaser for damages pursuant to this clause 8 or if one of the parties should have reason to believe that a claim may be advanced, this party shall immediately inform the other party to this effect.

§9 Escape clause (Force majeure):

The following circumstances shall mean an exemption from liability if they prevent AVK from performing a contract or make the performance unreasonably burdensome: fire, explosion, Act of God, epidemic, war, riot or civil commotion, unrest, martial law, mobilisation or similar military measures, seizures, currency restrictions, import and export prohibition, strike, lockout or other circumstances of a similar nature beyond the control of AVK, be it with AVK or with AVK' suppliers.

§10 Venue and law:

Any dispute which may arise between AVK and the customer shall be settled finally and binding on both parties by the District Court Zwolle in the Netherlands pursuant to Dutch law - unless a written acceptance has been given to the contrary.

When one or several of the above conditions are reversed totally or partly by a legal decision or by an amendment in legislation, this does not mean that the Terms and Conditions of Sale and Delivery shall be cancelled as a whole, but that they are amended according to the legal decision and/or to the amendment of law.



AVK Nederland BV

**Radeweg 12 (Sales)
8171 MD Vaassen
The Netherlands**

**T: +31 (0) 578574490
E: info@avknederland.nl
www.avknederland.nl**



AVK Rewag

**Schorsweg 1 (Production)
8171 ME Vaassen
The Netherlands**

**T: +31 (0)578560602
E: info@avkrewag.com
www.avkrewag.com**

AVK Nederland BV

Schorsweg 1
8171 ME-Vaassen
The Netherlands

Tel.: +31(0)578 560602
E-mail: info@avkrewag.com
Internet: www.avkrewag.com

2025-04-01
© 2025 AVK GROUP A/S - rev. 2

Expect... 